

User Guide

Revision 1.8

August 2025

Ultrasonic Personal Air Sampler

v2.1 and v2.1 PLUS

Firmware versions 158 and earlier



**ACCESS SENSOR
TECHNOLOGIES**

Sampling made simple.®

Notices

© Access Sensor Technologies LLC, 2025

No part of this manual may be reproduced in any form or by any means (including electronic storage and retrieval or translation into a foreign language) without prior agreement and written consent from Access Sensor Technologies as governed by United States and international copyright laws.

Revision:

Revision 1.8, August 2025

Published by:

Access Sensor Technologies LLC, Fort Collins, CO, USA

Technical Support:

<https://www.accsensors.com/>
support@accsensors.com

Contents

Abbreviations	5
1 Introduction.....	6
UPAS overview.....	7
2 What comes with the UPAS?.....	9
Items included with the UPAS.....	9
Items not included with the UPAS.....	10
3 Physical Setup.....	11
Cleaning and inspecting before sampling.....	11
Installing and removing the microSD card.....	12
Selecting filter media.....	12
Installing a filter cartridge and size-selective inlet.....	14
Power-on and off.....	15
Power-on sequence.....	15
Charging the battery and connecting external power sources.....	17
Charging the internal battery.....	17
Times the UPAS can be charged.....	17
Verify the battery state of charge (SOC).....	17
Charging when powered-on.....	17
Charging while actively sampling.....	17
Using external battery packs.....	17
Checking the flow rate with an external meter.....	18
Mounting the UPAS.....	19
Mounting the UPAS for personal sampling.....	19
Mounting the UPAS in a stationary location.....	20
4 Sample Programming with App.....	21
Installing and updating “AST UPAS” mobile application.....	21
Connecting the UPAS to the app.....	22
Configuring the MAIN SETTINGS in the app.....	24
Sample Name.....	24
Cartridge ID.....	24
Start Time.....	24
Sample Duration.....	27
Filter Inlet.....	27
Filter Flow Check & Adjust.....	28
Filter Flow Duty Cycle.....	30
PM Sensor Operation (v2.1 PLUS only).....	31
CO ₂ Sensor.....	32
CO ₂ Sensor Calibration.....	32
VOC/NO _x Sensor.....	33
GPS.....	33
LED.....	33

	Power Save	34
	Log Interval.....	34
	Monitor Config.....	34
	Motion and light sensors	34
	Start the sample	34
	App lock to hold sample settings (optional).....	35
	Special operating modes	35
	External power mode.....	36
	Always start on next power-on.....	36
5	UPAS Log File.....	38
	Accessing log files.....	38
	Log file legend	38
	Web-based data visualization tool (R-Shiny application)	50
	Sample Summary.....	50
	Plots.....	52
	GPS Map.....	53
	Providing Feedback	54
	R Package	54
	Analyzing filter sample data.....	54
	Interpreting time-resolved particulate matter sensor data	55
	Shutdown modes.....	56
	Shutdown Mode 0 or 60+: Unknown error, UPAS freeze, or UPAS crash	56
	Shutdown Mode 4: Thermal protection.....	57
	Shutdown Mode 5: Maximum power at initialization	57
	Shutdown Mode 6 or 7: Maximum pump voltage or blocked flow during sample	58
	Shutdown Mode 8: SD card removed during sample	58
6	Device Maintenance	59
	Internal lithium-ion battery	59
	Diagnostic test.....	60
	Installing and updating UPAS firmware.....	62
	Determine the firmware version installed on the UPAS.....	62
	Prepare for firmware installation.....	62
	Install the firmware.....	62
	Verify that the new firmware was installed successfully	62
7	Frequently Asked Questions	63
	The LED is blinking pink and I can't connect to the app. What should I do?	63
	What if the local timestamps in my UPAS log file look wrong?.....	63
8	UPAS Specifications.....	64
9	Returns, Warranty, and Repairs	66
	Limited product warranty.....	66
	Warranty conditions.....	67
	Return of non-defective products	67
	Procedures for obtaining warranty service.....	67
	After one-year warranty – post warranty repair.....	68
	Warranty exclusions.....	68

Abbreviations

Abbreviations used throughout this manual are defined below in alphabetical order:

ACGIH	American Conference of Governmental Industrial Hygienists
AST	Access Sensor Technologies
BLE	Bluetooth low energy
EPA	Environmental Protection Agency
GPS	Global Positioning System
ID	inner diameter
ISO	International Organization for Standardization
LED	light-emitting diode
Li-ion	Lithium-ion
NO _x	oxides of nitrogen
OS	operating system
PM	particulate matter
PM _{2.5}	refers to a particle size fraction, defined by the U.S. EPA, that generally consists of particles with aerodynamic diameters smaller than 2.5 μm; often called “fine particulate matter”
PM ₁₀	refers to a particle size fraction, defined by the U.S. EPA, that generally consists of particles with aerodynamic diameters smaller than 10 μm
QR	quick response
RH	relative humidity
SOC	state of charge
PTFE	polytetrafluoroethylene (Teflon™)
UPAS	Ultrasonic Personal Air Sampler
U.S.	United States
VOC	volatile organic compound

1 Introduction

Access Sensor Technologies' (AST) Ultrasonic Personal Air Sampler (UPAS) provides a new paradigm for streamlined assessment of exposure to air pollution. The UPAS collects a time-integrated sample of particulate matter (PM) onto a filter, using virtually-silent ultrasonic pumping technology, while logging time-resolved sensor data on sample flow rate; device location; device motion; air temperature, pressure, and relative humidity (RH); as well as other variables (depending on the UPAS model). The UPAS provides substantial reductions in size, weight, noise, and cost along with increased durability over traditional sampling equipment. AST's size-selective inlets and filter cartridges integrate directly with the UPAS body, thus eliminating the need for cumbersome tubing. The UPAS is silent and light enough to be worn in a person's breathing zone but can also be used for stationary sampling.

The UPAS system consists of two main components:

- A hardware component which can be worn in a person's breathing zone or mounted in a stationary location. Two versions of this hardware component are available: the UPAS v2.1 and the UPAS v2.1 PLUS (**Figure 1**).
- A software component with a Bluetooth® interface that allows the UPAS to be programmed using a free Android or Apple iOS mobile application (the "app").

This user guide describes both the hardware and the software components. It explains how to prepare and program the UPAS for sampling and then retrieve the UPAS sample data.



Figure 1. A UPAS v2.1 (left) and UPAS v2.1 PLUS (right) shown with a GEN2 PM_{2.5} 1 L min⁻¹ size-selective inlet (sold separately) and filter cartridge (sold separately) installed.



CAUTION: There are no user-serviceable parts inside the UPAS. Do not open the UPAS housing. Refer servicing to Access Sensor Technologies.

UPAS overview

The UPAS v2.1 and the UPAS v2.1 PLUS have many common features (**Figure 2**, left). Both measure particulate matter air pollution by sampling air at a regulated flow rate through a size-selective inlet onto a 37- or 25-mm-diameter filter. To collect a filter sample of PM using the UPAS, the user must install a size-selective inlet and filter in the inlet socket as shown in **Figure 3**.



CAUTION: Never run the UPAS filter pump without a 37- or 25-mm filter installed in the appropriate filter cartridge and an inlet threaded into the inlet socket. Otherwise, particulate matter may contaminate and damage the pumping elements.

The UPAS is powered on and off using the pushbutton on the front of the housing. The color of the pushbutton light (LED) indicates the operational state of the device (**Figure 4**). The UPAS is equipped with Bluetooth connectivity. An iOS (Apple) or Android mobile device application (the “app”) is used to program and start UPAS samples. The UPAS runs off an internal lithium-ion battery, which is charged via a micro-USB port. Sample log data are written to a microSD card in comma-separated .txt format. Log files can be transferred from the microSD card to a computer for analysis in your software of choice (e.g., R, Python, our web-based R-Shiny data visualization tool, or Excel).

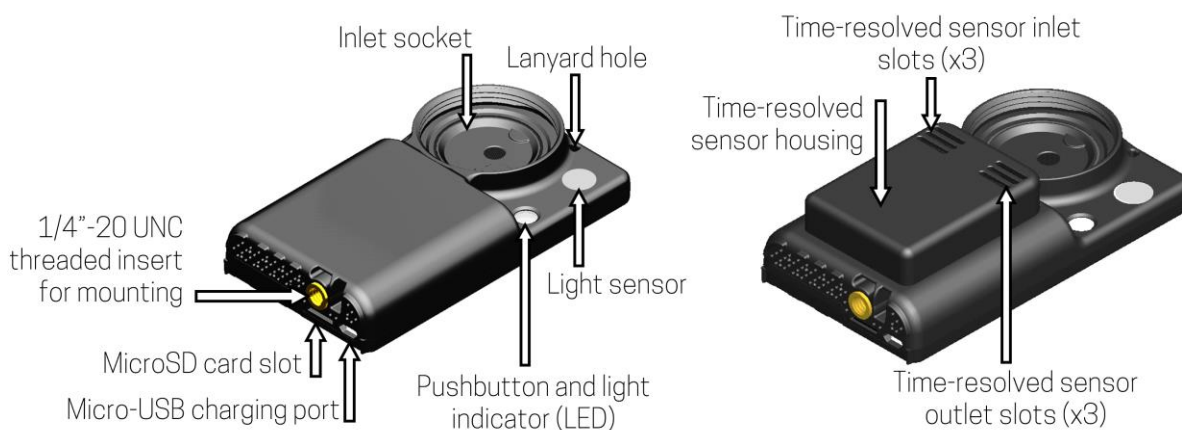

Figure 2. UPAS v2.1 (left) and UPAS v2.1 PLUS (right) with key components identified.

In addition to the core features included in the v2.1, the v2.1 PLUS (**Figure 2**, right) includes time-resolved sensors for particulate matter (Sensirion SPS30), CO₂ (Sensirion SCD41), total volatile organic compounds (Sensirion SGP41; qualitative), and NO_x (Sensirion SGP41; qualitative). On the UPAS v2.1 PLUS, the air flow path for the filter sample (air path 1) is independent of the air flow path for the time-resolved sensors (air path 2; see **Figure 3**). The UPAS v2.1 PLUS can operate and log data from the time-resolved sensors without collecting a filter sample. The air at the outlet of path 1 has been filtered by the filter sample media. No filtering occurs in path 2. Make sure all inlets and outlets remain unblocked during sampling.

For all UPAS versions, the common features shown in **Figure 5** can be found on the back housing. Each UPAS is identified by a unique serial ID on the back housing.

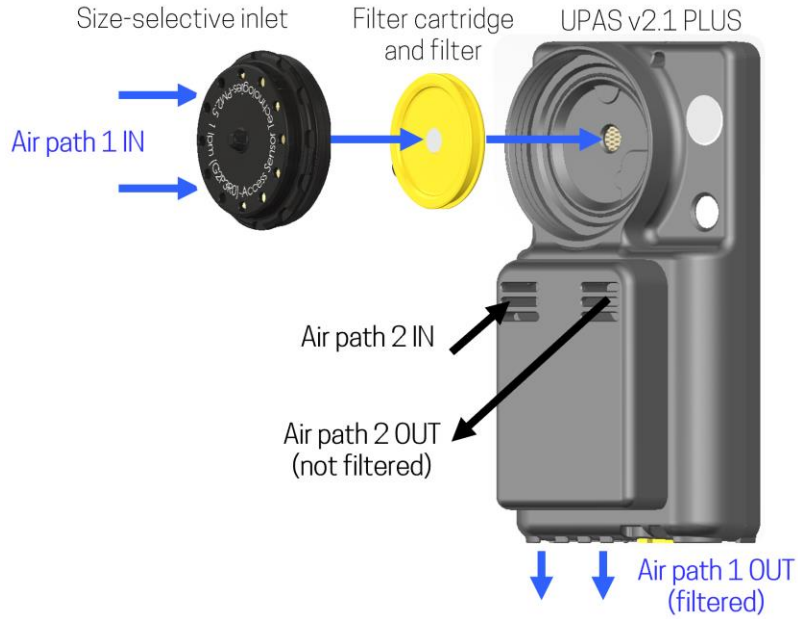

Figure 3. Air flow paths for the filter sample and time-resolved pollutant sensors on the UPAS v2.1 PLUS. A GEN2 PM_{2.5} 1 L min⁻¹ size-selective inlet and 37-mm filter cartridge are shown here as examples. Other size-selective inlets and a 25-mm filter cartridge are also available (sold separately).



Figure 4. Possible UPAS pushbutton light (LED) colors.



Figure 5. Back of the UPAS housing with key components identified.

2 What comes with the UPAS?

Items included with the UPAS

The UPAS comes with the kit of parts listed in **Table 1**. Contact AST if you are missing any items or would like to purchase extra items.

Table 1. Items included with each UPAS.

Item description	Application or location note	Quantity per UPAS
Spare O-ring, 35-mm ID × 1-mm CS, Buna 70	Inlet socket	1
MicroSD card	Bottom of UPAS	1
MicroSD card adapter	MicroSD to SD adapter	1
Cleaning swab (v2.1 PLUS only)	Time-resolved sensor slot cleaning	1

The UPAS is shipped with the microSD card shown in **Figure 6**. We strongly recommend using only this model of microSD card with the UPAS. If a different model of microSD card is used, the UPAS log file could fail to write. To purchase additional UPAS-compatible microSD cards, contact AST, use the search term “SanDisk Industrial microSD, 8GB SDHC UHS-I Class 10” to find the card shown in **Figure 6**, or find another card with the specifications detailed in **Table 2**.

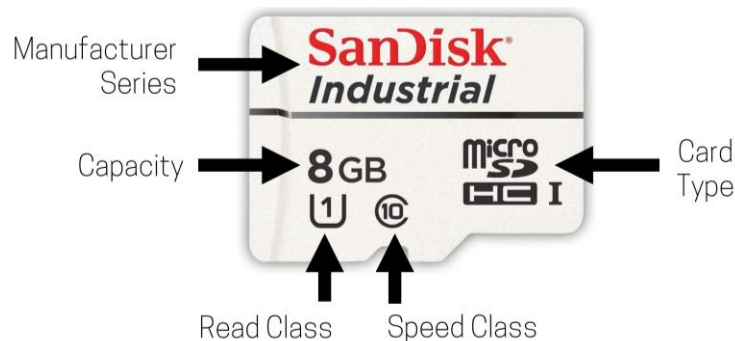

Figure 6. SanDisk Industrial microSD, 8GB SDHC UHS-I Class 10, compatible with and included with the UPAS.

Table 2. Specifications for UPAS-compatible microSD cards.

Specification	Detail
Manufacturer/series	SanDisk/Industrial
Card Type	microSDHC
Capacity	8GB
Speed class	Class 10, 10Mb/s
Read Class	UHS read class 1, 10 Mb/s
Included Accessories	SD adapter for use in full-sized SDHC/SDXC slots

Items not included with the UPAS

Size-selective inlets, filter cartridges, and related accessories are sold separately. All UPAS versions are compatible with all AST size-selective inlets and filter cartridges (**Figure 7**). A GEN2 Filter Inlet Tool and G2 Filter Cartridge Opening Tool are also available but not pictured in **Figure 7**. Review the Size-Selective Inlet User Guide for more information. Accessories for charging, flow rate calibration, and mounting are also sold separately (**Table 3**). Sample filters are not included with the UPAS nor sold by Access Sensor Technologies.

IMPORTANT! GEN1 filter cartridges are NOT cross-compatible with GEN2 inlets. Similarly, GEN2 filter cartridges are NOT cross-compatible with GEN1 inlets.

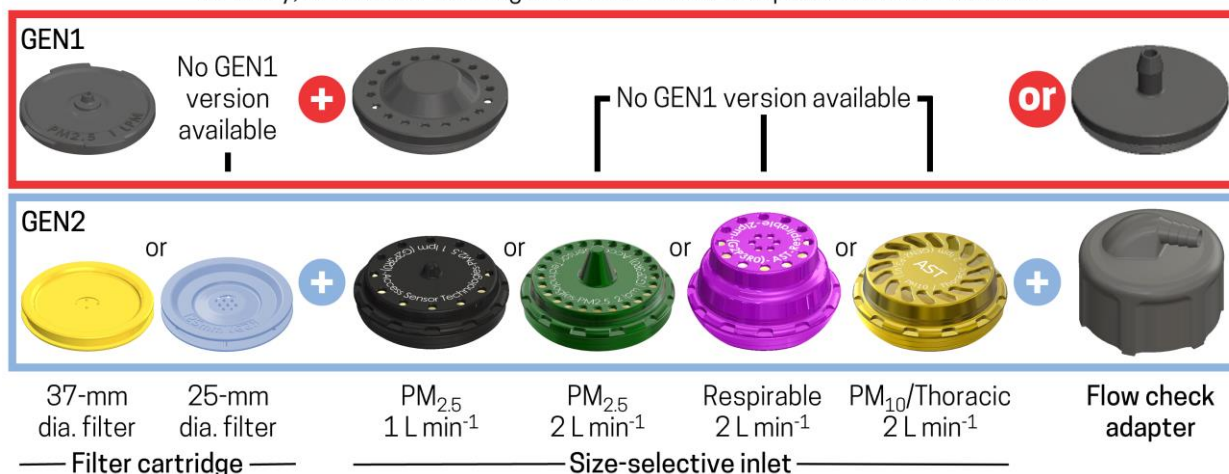

Figure 7. Summary of Generation 1 (GEN1) and Generation 2 (GEN2) size-selective inlet systems, filter cartridges, and accessories.

Table 3. Optional accessories available for purchase, not included with UPAS.

Item description	Application or location note
USB-A to micro-USB cable, rated for 5 V and 2 to 3 Amps	Charge UPAS or update firmware
Wall adapter to USB-A, rated for 5 V and 2 to 3 Amps; type B (US) and type F (EU) available	Charge UPAS
Alicat flow rate meter (recommended)	Flow calibration
Lanyard, tripod, chest harness, armband, etc.	Mount UPAS for sample
Outdoor enclosure	Install the UPAS outdoors for fixed-site sampling

3 Physical Setup

Cleaning and inspecting before sampling

Before sampling, clean the UPAS housing, size-selective inlet, and filter cartridge. Refer to the Size-Selective Inlet User Guide for best practices for cleaning the inlet and filter cartridge. Clean the outside of the UPAS housing with a soft, lint-free cloth dampened with water, soap solution, ethanol, or isopropyl alcohol. Do **not** use any other chemical solvents, such as acetone, as these can damage the UPAS housing. Keep moisture away from the microSD card port and micro-USB port on the bottom of the UPAS. Wipe the inlet socket and threads while avoiding the inlet screen (**Figure 8**).

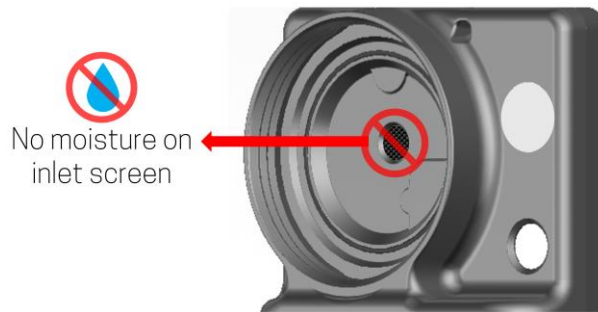

Figure 8. Do not expose the inlet socket screen to moisture when cleaning or at any other time.

Locate the black O-ring (35-mm ID × 1-mm CS) inside the inlet socket (**Figure 9**). Ensure this O-ring is present, evenly seated in the groove, and in good condition.

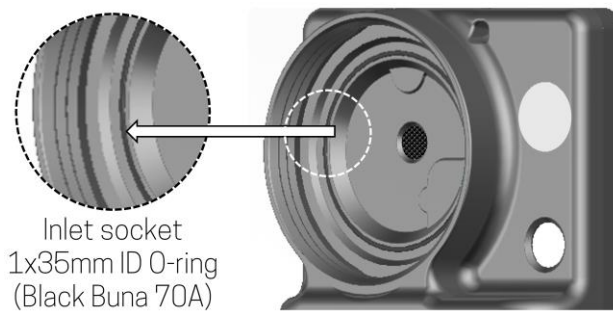

Figure 9. UPAS inlet socket O-ring, black, 35-mm ID × 1-mm CS, Buna 70A, common to all UPAS versions.

For the UPAS v2.1 PLUS, inspect the six slots on the time-resolved sensor housing. Ensure the slots are free of debris. Use a lint-free swab lightly wetted with water, ethanol, or isopropyl alcohol to clean the slots. Do not press the swab into the slots all the way; only clean the openings (**Figure 10**).

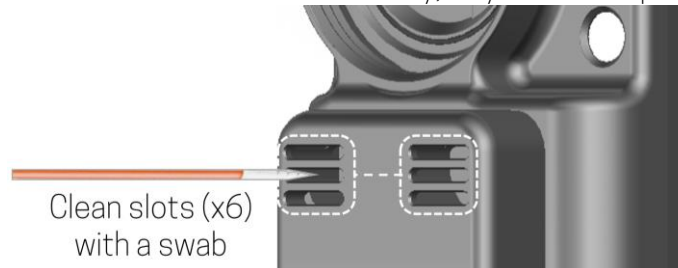

Figure 10. Use a swab to clean the air flow slots on the time-resolved sensor housing.

Installing and removing the microSD card

Before powering-on the UPAS, ensure that a UPAS-compatible microSD card is installed in the slot on the bottom of the UPAS (**Figure 2**).

Installing a microSD card in the UPAS.

- 1 Verify the microSD card is clean, in good condition, and compatible with the UPAS. Specifications for compatible microSD cards are provided in **Figure 6** and **Table 2**.
- 2 Insert the microSD card into the slot on the bottom of the UPAS (under the threaded mounting hole; see **Figure 2**). The gold metal tabs on the microSD card face the back of the UPAS. The microSD card will not insert all the way or snap into place if it is upside down or backwards.
- 3 Gently push the card in with a coin, paper clip, ball point pen tip, or your fingernail until you feel it click into place.
- 4 Release the card. It will rebound slightly and then stop in the installed position (set in ~1 to 2 mm from the outside edge of the UPAS housing). Verify that the card is in this position and not protruding from the housing face. If the card is protruding, try to push it back in (Step 2).

To remove the microSD card, press the microSD card further into the UPAS housing—using a small coin, paper clip, ball point pen tip, or your fingernail—and then release the card. The microSD card will pop out of the housing and can then be removed with your fingers or tweezers.

Do not remove the microSD card while the UPAS is powered on or while sampling. If the microSD card is removed during programming, or between the programming step and the time when the sample is programmed to start, the UPAS will power off five minutes after the sample initiates. If this happens, power the UPAS off, install the microSD card, and power the UPAS back on. The previously-programmed sample will start again automatically.

If a sample is started with an incompatible microSD card installed in the UPAS, the LED will flash red, the pumps will not start, and no log file will be created. In this case, the user must power-off the UPAS, install a compatible microSD card, power the UPAS back on, and reconnect with the app to reprogram and restart the sample.

Selecting filter media

AST offers two sizes of filter cartridges to facilitate sampling onto 37- or 25-mm-diameter filters. Refer to **Table 4** for information on 37-mm filters AST has tested with the UPAS. Currently, no relative flow resistance data are available for 25-mm filters.

Table 4. 37-mm-diameter filters that have been tested by Access Sensor Technologies for use with our ultrasonic sample pumps.

Gravimetric analysis	Dissolvable (for chemical analysis)	Scannable via XRF, etc.	Microscopy analysis	Biological sampling	Thermal-optical elemental and organic carbon (EC/OC) analysis	Relative flow resistance (lower means lower power consumption)	Manufacturer	Product family	Product ID	Filter media material type	Filter media pore size (µm)	Support ring material
+	-	+	+	+	-	1.0	Tisch Scientific	PTFE	SF17382	PTFE (Teflon™) membrane	5.0	None
+	-	+	+	+	-	1.2	GE Lifesciences Whatman	TE 38	10411108	PTFE (Teflon™) membrane	5.0	None
+	-	+	+	+	-	1.3	Pall Laboratory	Teflo	R2PJ037	PTFE (Teflon™) membrane	2.0	PMP ring
+	-	+	+	+	-	1.7	Measurement Technology Laboratories (MTL)*	PTFE	PT37P-PF03	PTFE (Teflon™) membrane	2.0	FEP ring
+	±	+	+	+	-	4.2	SKC	PVC	225-5-37	PVC membrane	5.0	None
±	-	±	-	-	+	5.0	Pall Laboratory	Tissuquartz	2500QAT-UP	Quartz fiber (unbonded)	-	None
+	-	+	-	-	-	5.1	Pall Laboratory	EMFAB	Tx40HI20WW-37 mm	Borosilicate microfiber w/ woven glass, PTFE bonded	-	None
+	-	+	+	+	-	6.6	Pall Laboratory	Zefluor	P5PJ037	PTFE (Teflon™) membrane	2.0	PTFE ring
±	+	+	+	+	-	10.0	SKC	MCE	225-1938	Mixed cellulose ester (MCE) membrane	5.0	None
±	+	+	+	+	-	16.2	SKC	MCE	225-1939	MCE membrane	0.8	None
±	+	+	+	+	-	16.2	SKC	MCE	225-334	MCE membrane	0.8	None
±	+	+	+	+	-	17.7	EMD Millipore	MF	AAWP03700	MCE membrane	0.8	None
±	+	+	+	+	-	19.0	GE Lifesciences Whatman	ME27	10400909	MCE membrane	0.8	None
+	Typical use		±	Optional use		-	Not typically used					

* Access Sensor Technologies recommends these filters for UPAS samples intended for gravimetric, optical black carbon, and XRF analyses

Installing a filter cartridge and size-selective inlet

To collect a filter sample of particulate matter using the UPAS, three main components are required: a filter, a filter cartridge, and a size-selective inlet. Filters are supplied by the user; cartridges and inlets are sold separately by AST. All filter cartridges and size-selective inlets made by AST are compatible with all UPAS versions (see **Figure 7**). Review the Size-Selective Inlets User Guide to see all available parts and to learn more about how to use the size-selective inlets, the filter cartridges, and related accessories.

Install the filter in the filter cartridge. Place the cartridge in the inlet socket so the side with a single hole faces up and the side with a ring of many small holes plus the QR code faces down (**Figure 11**).

Application note: If you plan to enter the filter cartridge ID into the UPAS app by scanning the QR code, connect to the UPAS using the app and start programming the sample (**Section 4**) before installing the filter cartridge and inlet on the UPAS. Alternatively, note the filter cartridge ID before installing it in the UPAS so that you can enter the ID into the app manually.



Figure 11. A filter cartridge placed in the UPAS inlet socket. The side with a ring of many small holes plus the QR code must face down. A GEN2 37-mm cartridge is shown here; installation of the 25-mm cartridge is similar.

Place the size-selective inlet on top of the filter cartridge and turn the inlet clockwise to thread it into the inlet socket (**Figure 12**).

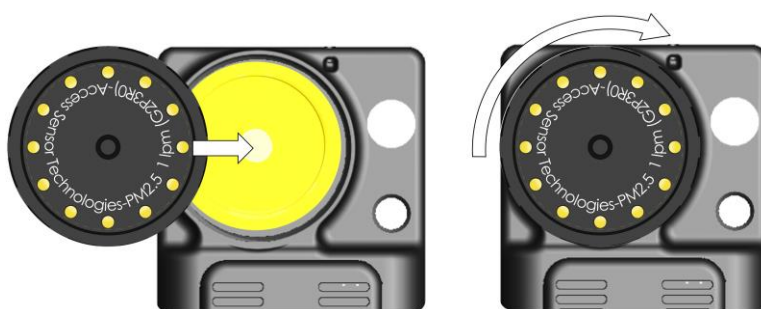

Figure 12. Start installing the inlet by turning it clockwise into the inlet socket. A GEN2 PM_{2.5} 1 L min⁻¹ inlet and GEN2 37-mm filter cartridge are shown in this example. Installation of other inlets and cartridges is similar.

When installing a GEN1 PM_{2.5} 1 L min⁻¹ inlet, use the knurled collar to tighten the inlet the rest of the way by hand. When installing a GEN2 inlet, attach the Filter Inlet Tool (**Figure 13**) or Flow Check Adapter (**Figure 14**) to the inlet, so the teeth on the bottom of the adapter engage with the grooves around the circumference of the inlet, and use the filter inlet tool or flow check adapter, instead of your bare hand, to turn the inlet clockwise until it is fully tightened in the socket.



Figure 13. Attach the GEN2 Filter Inlet Tool to the size-selective inlet and turn clockwise to tighten fully.



Figure 14. Attach the GEN2 Flow Check Adapter to the size-selective inlet and turn clockwise to tighten fully.

Power-on and off

To turn the UPAS on, press the pushbutton firmly until it clicks. Continue holding the pushbutton down for 5 s until the light (LED) turns on. Release the button. Note that the pushbutton requires an uninterrupted hold down of at least 5 s. If the pushbutton press is interrupted, the UPAS does not power on and you will have to start a new 5-s-long press. The pushbutton light should briefly turn **green** to indicate the UPAS is powering on (**Figure 15**).

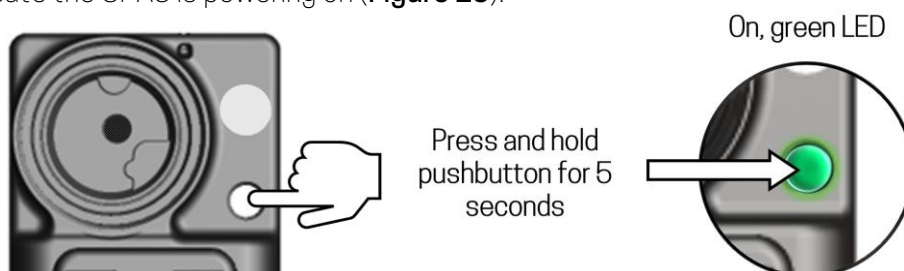

Figure 15. UPAS power-on sequence.

To power the UPAS off, repeat the 5 second pushbutton press and hold until the LED turns off.

Power-on sequence

The pushbutton light (LED) changes colors to indicate the status of the UPAS (**Figure 4**). When powered-on, the UPAS will automatically progress through a sequence of checks before the user can connect to the UPAS with the app. Reference **Table 5** to interpret the power-on sequence.

Table 5. UPAS power-on sequence.

Power-on Sequence		LED status	Meaning
1	Power-on UPAS by pressing power button for > 5 s	Green LED on	UPAS is powered on and checking sensors
2	Initialize GPS and check for microSD card	Orange LED on	UPAS turns on GPS and checks if a microSD card is installed
3	Wait for microSD card installation if not already installed	Orange LED flashes indefinitely	No microSD card is installed in the UPAS ¹
4	Checking for GPS timestamp and signal	Orange LED on	UPAS checks for GPS signal quality and if a timestamp has been synchronized
5	Synchronize GPS timestamp ²	Pink LED flashes indefinitely	GPS timestamp is not synchronized. UPAS power-on sequence stops if it needs GPS synchronization.
6	Check “At Next Power-On” state ³	Orange LED on	UPAS checks if it should continue the power-on sequence or start a sample
7	Battery State of Charge (SOC) ^{4,5} Indication (UPAS flashes one of these codes)	Blue LED flashes 1×	SOC is < 25%
		Blue LED flashes 2×	SOC is 25 to 50%
		Blue LED flashes 3×	SOC is 50 to 75%
		Blue LED flashes 4×	SOC is 75 to 96%
		Blue LED flashes 4× then green flashes 1×	SOC is > 96%
8	Get sensor serial numbers and power on Bluetooth® Low Energy (BLE)	Orange LED on	Powering on BLE to allow for Android/iOS app programming
9	Power-on sequence is complete	Pink LED on	Ready to connect to Android/iOS app for sample programming

1. A microSD card must be installed to use the UPAS. All data are logged to the microSD card. If the microSD card is missing, the power-on sequence will stop here until a microSD card is installed.
2. Set the GPS timestamp by placing UPAS outdoors where it can capture a GPS signal. The UPAS should obtain a GPS signal, and the power-on sequence should continue, within 5 to 15 minutes. If the GPS timestamp is missing, the power-on sequence will stop here until the GPS timestamp is synchronized.
3. If the UPAS was previously set to a Start Date/Time of “At Next Power-On” via the Android/iOS app, then the UPAS will start the sample after indicating the Battery State of Charge. BLE will not be turned on in this case.
4. If the UPAS is plugged into a computer or charger and powered on, and that UPAS is not in “external power mode” (see Section 4), the LED will display a repeating charge-status light sequence until the UPAS is unplugged, and Bluetooth will not be available for connection.
5. If the UPAS is powered-on and then connected to a computer or charger, the normal LED indicators will continue, and Bluetooth connection will become available.

Charging the battery and connecting external power sources

Charging the internal battery

To charge the UPAS battery, use a USB type A to micro-USB cable to connect the UPAS to a computer or USB wall power adapter. A USB charger and cable capable of providing at least 2 Amps at 5 V will charge a fully-depleted battery in 4 hours. We do not recommend using charging hardware rated for less than 2 Amp output; such hardware might take a much longer time to fully-charge the UPAS. The UPAS can charge the battery when the UPAS internal temperature is between 0 °C and 45 °C (**Section 8** UPAS Specifications).

Times the UPAS can be charged

The UPAS can be charged while powered off or while powered on. The UPAS can be charged when not in use or while actively sampling. The UPAS will manage the battery charging rate, including trickle and maintenance charging, any time it is connected to a compatible and reliable charging source.

Verify the battery state of charge (SOC)

When powered on, the UPAS displays the battery SOC (**Table 5**) at least one time before proceeding with the startup sequence. This is one way to determine the approximate battery SOC. The battery SOC will also be displayed in the app when a UPAS is connected for programming (see Section 4).

Charging when powered-on

If a UPAS is connected to a charging source before being powered on, and that UPAS is not in “external power mode,” the battery SOC will display repeatedly when the UPAS is powered on, and the UPAS will not continue to progress through the power-on sequence or become available for connection to the mobile app, until the UPAS is disconnected from the charging source.

Charging while actively sampling

If you want to charge the UPAS while actively sampling—via a wall outlet, external battery pack, or solar panel—we recommend putting the UPAS in external power mode. In external power mode, the UPAS will progress all the way through the power-on sequence and become available to connect to the app when powered on while plugged in and charging. See Section 4 for instructions on how to put the UPAS into external power mode using the app. When actively sampling, the UPAS LED will indicate the battery charging state and warn when the battery is low (**Table 6**).

Application note: The UPAS can sample indefinitely (i.e., the sample duration will not be limited by the battery capacity) while plugged into a wall outlet.

Using external battery packs

If you require extended sample runtimes beyond what the UPAS internal battery can support, and the added weight and complexity are acceptable, you can connect an external battery pack to the UPAS micro-USB port. We recommend using **Voltaic battery packs** (e.g., models V15, V25, V44, V50, V75) in “always-on” mode to charge the UPAS. These are the only external battery packs that are known to

reliably power the UPAS for extended runtimes. *The battery pack must be operated in always-on mode.* Follow the instructions from the external battery manufacturer to make sure the model you are using is in always-on mode. An external battery pack that is not equipped with always-on mode (or does not have always-on mode enabled) may fall asleep when the UPAS is fully charged and fail to turn back on when the UPAS is ready to accept charge again. Follow these instructions to ensure a Voltaic V15 or V44 battery is in “always-on” mode: <https://youtu.be/PyqMq2E10v0>

If a UPAS is connected to an external battery pack before powering on, and that UPAS is not in external power mode, the battery SOC will display repeatedly when the UPAS is powered-on and the UPAS will not continue through the power-on sequence or become available for connection to the mobile app. If you want to sample with the UPAS connected to an external battery pack, we recommend putting the UPAS into external power mode. External power mode will allow the UPAS to progress all the way through the power-on sequence and become available to connect to the app when the UPAS is powered on while connected to the external battery. See Section 4 for instructions on how to put the UPAS into external power mode using the app.

Table 6. Meaning of UPAS pushbutton light (LED) colors when actively running a sample.

LED color	Meaning	Recommended action
Green	UPAS is sampling and not charging	No action required
Blue	UPAS is sampling and charging	No action required
Pink	UPAS is sampling and fully charged	No action required
Orange	UPAS battery is low	Plug the UPAS into a charging source while the sample is running.
Red ¹	UPAS flow is obstructed and the pumps are at maximum power ¹	Verify the inlet is unobstructed.

1. If the red LED is displayed for more than 3 minutes, the UPAS will stop the sample and power off. See the log file shutdown mode to identify the cause of the red LED (Table 12).

Checking the flow rate with an external meter

We recommend using Alicat Whisper™ MW- or MWB-Series Low Pressure Drop Mass Flow Meters with the UPAS. Specific part numbers that we recommend are as follows:

Model number	Specifications
MWB-5SLPM-D	For checking flow rates up to 5 L min ⁻¹ ; portable battery-powered version
MW-5SLPM-D	For checking flow rates up to 5 L min ⁻¹ ; line-powered version

Other meters that can be used include the Bronkhorst® LOW-ΔP-FLOW F-101D, A.P. Buck mini-BUCK™ Calibrators, and the BGI triCal® or tetraCal®.

Do not use an Alicat M-series meter or a piston-type flow meter (e.g., DryCal®) with UPAS. The UPAS filter sampling flow rate can only be measured using a flow measurement device that is non-pulsative and has a relatively low pressure drop. Therefore, no moving-piston type meters may be used with UPAS. Flow measurement devices that impose relatively high pressure drops or use moving pistons will result in large measurement errors or will make flow measurement impossible.

Connect a flow rate meter to the UPAS inlet as shown in **Figure 16**. Press the flow check adapter over the size-selective inlet, making sure the teeth on the bottom of the flow check adapter are aligned with the grooves around the circumference of the inlet cap. Press the flow check adapter down until it clicks into place and the internal O-ring seals around the groove in the inlet cap. Use a flexible piece of tubing to connect the barb on the top of the flow check adapter to the flow meter.

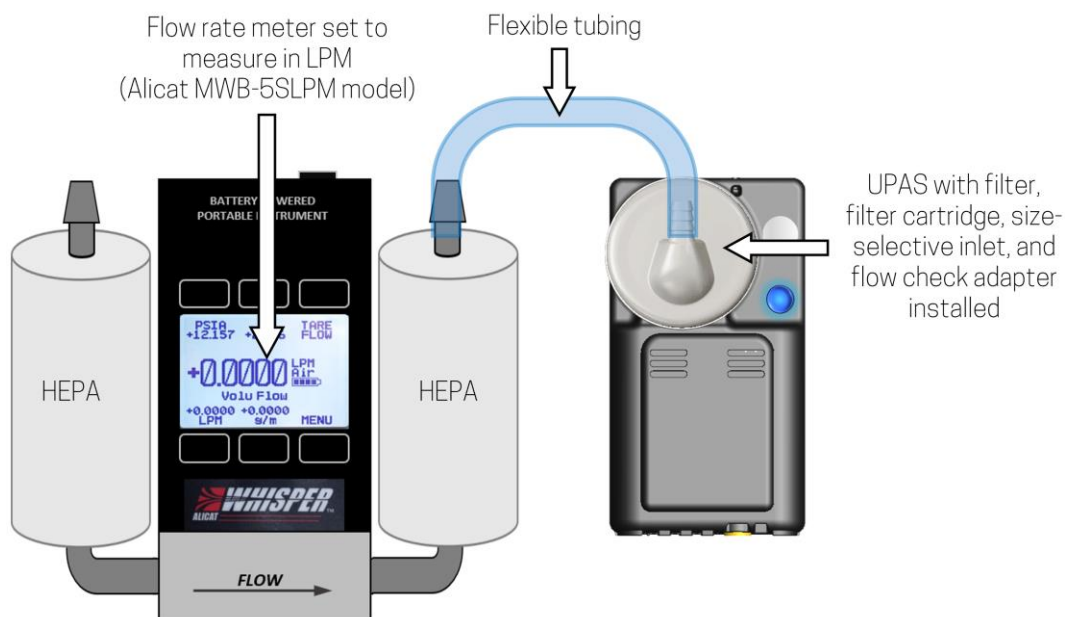

Figure 16. An Alicat MWB-5SLPM flow rate meter with dual in-line HEPA filters connected to a UPAS v2.1 PLUS with flexible tubing. The UPAS v2.1 PLUS is configured for flow check with a filter (in a filter cartridge), size-selective inlet, and flow check adapter installed (all GEN2 parts).

Mounting the UPAS

The UPAS may be worn as a personal sampler or mounted in a stationary location for area monitoring. The UPAS must always be shielded from rain, snow, and water spray.

Mounting the UPAS for personal sampling

To collect a good personal air sample, the participant should wear the UPAS as near as possible to their breathing zone. Placing the UPAS in the breathing zone allows the UPAS to sample the same air the participant is breathing. The personal breathing zone is defined as the area immediately surrounding a person's nose and mouth where most of the air is drawn into the person's lungs.

Several possible solutions exist to fit the UPAS to participants:

- A lanyard suspending the UPAS from the participant's neck (see lanyard hole in **Figure 2**).
- A harness that holds the UPAS firmly against the participant's body over the collar bone.
- An industry safety vest with attachment points for proper breathing zone mounting.

When fitting the UPAS to a participant, adhere to the following guidelines:

- Always follow the protocol of the agency or organization sponsoring the air test.

- The UPAS must always be worn outside of clothing.
- Make sure the front of the UPAS faces outward and does not get covered or blocked by clothing or other items during the sample.
- Make sure the air outlet on the bottom of the UPAS (i.e., the outlet of air path 1 in **Figure 3**) has an unobstructed path to ambient air that does not pass by the size-selective inlet or time-resolved sensor housing inlet (i.e., the inlets of air paths 1 or 2 in **Figure 3**). For example, avoid placing the UPAS in a pocket that is not ventilated (i.e., not mesh) on the bottom. If the UPAS is placed in a non-ventilated pocket, the filtered air exiting the bottom of the UPAS will be forced to flow out of the top of the pocket near the size-selective and time-resolved sensor housing inlets. This arrangement can cause filtered air to be re-sampled by the UPAS, which will result in erroneously low measurements of PM concentration.
- Participants should remove the sampler when sleeping or bathing.

Mounting the UPAS in a stationary location

For indoor fixed-site sampling, the UPAS can be laid down or mounted vertically with the back of the housing against a flat surface (e.g., table, countertop, cabinet). The UPAS can also be mounted on a tripod. The UPAS housing features a 1/4"-20 UNC threaded insert (**Figure 2**) to facilitate connection to a standard camera tripod. When mounting the UPAS on a tripod, always ensure that the UPAS is protected from damage by contact or collision with any objects, vehicles, etc.



CAUTION: The black UPAS housing is not waterproof. The UPAS must always be shielded from precipitation and water spray. When installing the UPAS outdoors, an additional shelter or enclosure is required to protect the UPAS from water damage that could result from exposure to rain or snow.

An outdoor enclosure (sold separately) is available for outdoor fixed-site sampling with the UPAS (**Figure 17**). This enclosure protects the UPAS from rain and snow. An external battery pack can be installed in the enclosure along with the UPAS. The UPAS can also be connected to line power or a solar panel while installed in the enclosure. The enclosure comes with a bracket that: (a) facilitates mounting to a pole or tripod and (b) allows a solar panel or sunshade to be attached above the enclosure. Visit our website to learn more: <https://www.accsensors.com/products>.



Figure 17. Left: View of the UPAS outdoor enclosure from the ground with a UPAS v2.1 PLUS installed. Right: A top view of the enclosure with a solar panel installed.

4 Sample Programming with App

A free mobile device application (the “app”) is required to set up the UPAS for sampling. Apple (iOS) and Android versions of the app are available. The Apple and Android apps have minor layout and user interface differences but the same overall functionality. The iOS app is compatible with devices running iOS 12 or later. The Android app is compatible with devices running Android 12 or later. Note:

- Internet access is required to download the app to the mobile device.
- Verify that Bluetooth is enabled on the mobile device before trying to connect to a UPAS.
- The “AST UPAS” app does not share or store any personal device or app data/history, including QR scan images. To use the optional QR code scanning feature, approve permissions for the app to access the mobile device camera.
- The mobile device (e.g., phone, tablet) is only needed for programming the UPAS; the mobile device used for programming does not need to stay near the UPAS during the sample. The UPAS disconnects from the mobile device when sample set up is complete.

Installing and updating “AST UPAS” mobile application

Users with mobile devices running the Apple operating system (iOS) can download the current “AST UPAS” App from the Apple App store via the following steps (**Figure 18**).

- 1 Find the Apple App store icon on your mobile device desktop.
- 2 Search for “AST UPAS”. This is a free App.
- 3 Select “GET” to install the application on your mobile device.
- 4 Select “Accept” for all defaults and access requirements.



Figure 18. Summary of App download process for an Apple (iOS) mobile device.

Users with mobile devices running the Android operating system can download the current “AST UPAS” App from the Google Play Store using the following steps (**Figure 19**).

- 1 Find the Google Play Store icon on your mobile device desktop.
- 2 Search for “AST UPAS”. This app is free.
- 3 Select “Install” to install the application on your mobile device.
- 4 Select “Accept” for all defaults and access requirements.



Figure 19. Summary of App download process for an Android mobile device.

Connecting the UPAS to the app

Open the AST UPAS app on your mobile device. When the app opens, Apple users will be directed to the Main Menu and Android users will be directed to the Available Devices screen. Reference the UPAS connection sequences for Apple and Android devices in **Figure 20**.

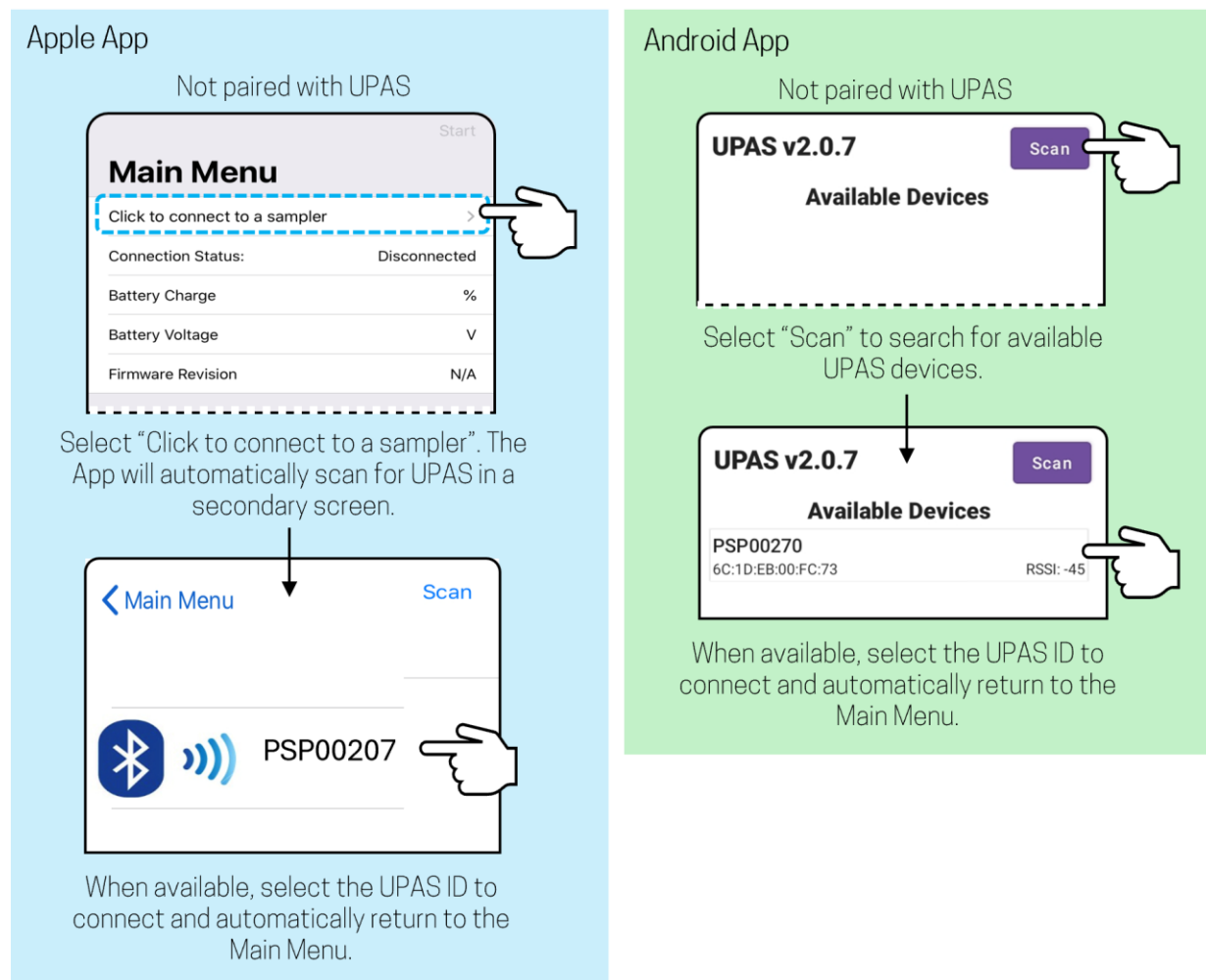
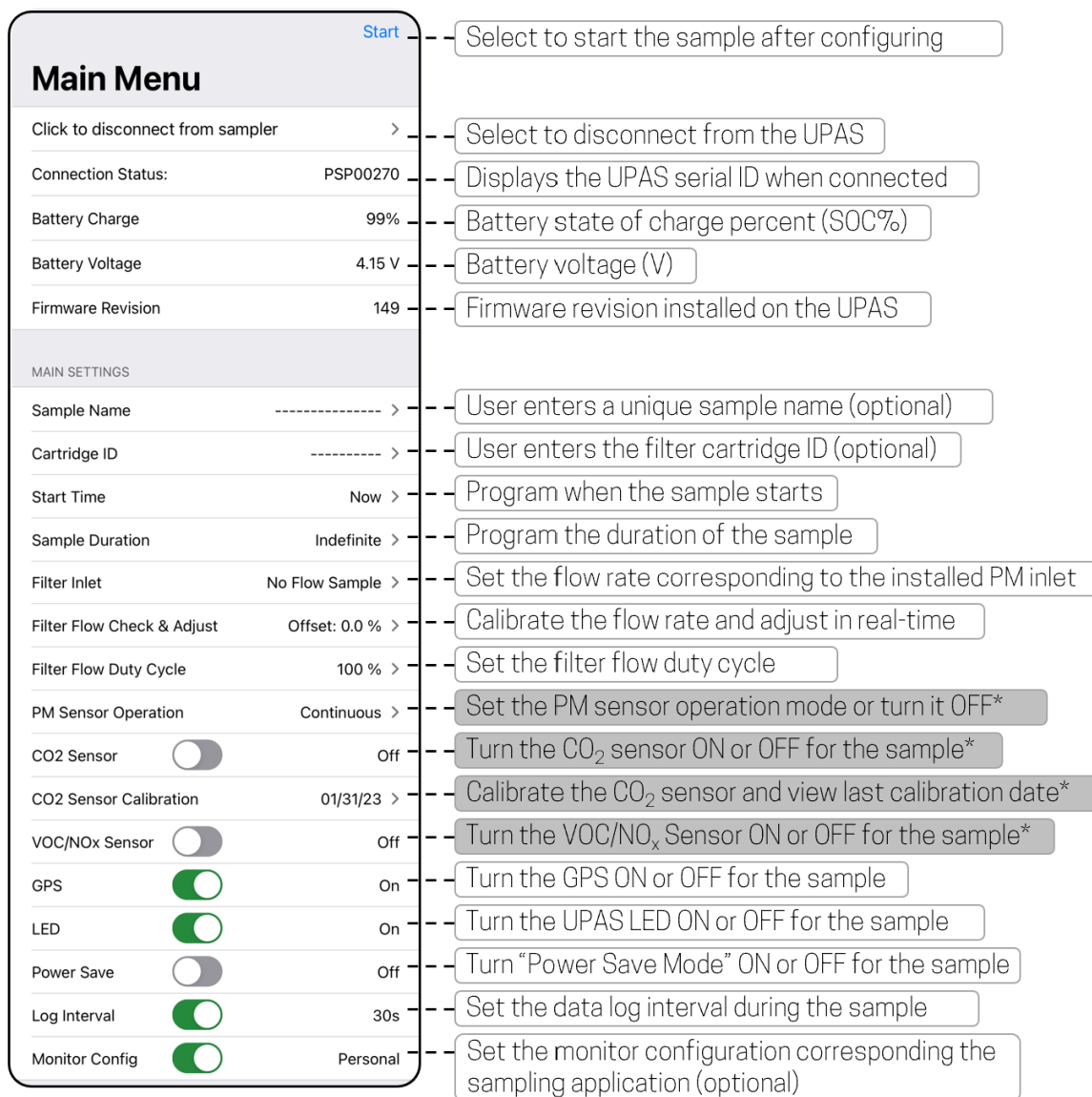

Figure 20. The screen that appears when the "AST UPAS" app is opened and the initial connection sequence for Apple users (left) and Android users (right).

Verify that the UPAS LED is solid pink before attempting to scan and connect. If multiple UPAS are on and available to connect, multiple UPAS serial IDs will be displayed after the scan. Re-scan as many times as needed until the device you are looking for appears.

On the main menu, allow the UPAS a few moments to establish the BLE connection. When the UPAS has connected, the LED will change from solid pink to solid blue. In the top section of the main menu, the “Connection Status”, “Battery Charge”, “Battery Voltage”, and “Firmware Revision” lines will update. The “MAIN SETTINGS” will also update to reflect the current sample settings. Every time a UPAS connects to the app, the “Sample Name” and “Cartridge ID” will be cleared, and the “Start Time” will default to “Now”. All other settings will remain as set from the previous connection event or sample run (**Figure 21**).



*These fields will be greyed out, and not changeable, when connected to a UPAS v2.1.

Figure 21. Example of the AST UPAS app Main Menu (Apple) when connected to a UPAS. Components in the main menu that are common to Apple and Android devices are identified.

If the UPAS battery is fully-charged, the battery charge will display 99% to 100%, and the battery voltage will display 4.0 to 4.25 V. We recommended verifying that the battery is fully-charged before starting a sample.

Configuring the MAIN SETTINGS in the app

The main menu (**Figure 21**) contains programmable settings for the sample. All sample settings from the app are recorded in the sample log file.

To change settings controlled with a simple on or off status, tap the toggle switch in the Apple app, and tap the “on” or “off” text in the Android App. For settings with more complex options, tap anywhere on the setting bar to access a secondary screen where the setting can be changed. After changing any setting in a secondary screen, verify that the change is reflected on the main menu screen before starting the sample.



CAUTION: Before starting a sample, verify that a 37-mm or 25-mm filter is installed in the appropriately-sized filter cartridge and that a size-selective inlet is fully threaded into the inlet socket. If the UPAS is operated without a filter cartridge installed, particulate matter may contaminate and damage the pumping elements.

Sample Name

Enter a user-generated alphanumeric sample name using the keyboard or by scanning a QR code (not included). The user can enter/scan up to 15 characters of text. Do not use special characters, especially “\” or “/”; you can use “-” OR “_” as separators as needed. The sample name becomes part of the suffix in the log file name and is stored in the log file data. This field is optional and can be left blank.

Cartridge ID

Enter a user-generated alphanumeric ID, or the unique ID on the sticker on the bottom of the filter cartridge, using the keyboard or by scanning a QR code. The user can enter up to 10 characters of text. Do not use special characters, especially “\” or “/”; you can use “-” OR “_”. The Cartridge ID becomes part of the suffix in the log file name and is stored in the log file data. This field is optional and can be left blank.

Start Time

Three “Start Time” options are available (**Figure 22**). Select the option suited for your application. When the sample is started from the main menu, each option will have the effect described below. Reference **Table 7** for the sample start sequence associated with each of these options.

- **Now:** The UPAS sample initiates immediately.
- **At Next Power On:** The next time the UPAS is powered on, the pre-programmed sample will start automatically.

Application note #1: This feature allows the UPASs to be programmed before deployment so that the in-field user only needs to power on the UPAS with the pushbutton to start the

sample. After the sample runs for the pre-programmed duration, or the UPAS is powered off with the pushbutton, the UPAS will need to be reprogrammed using the app before another sample can be collected.

Application note #2: This “At Next Power On” feature is different from the “Always Start On Next” feature described below. The Always Start On Next feature does not require re-connecting to the app to start multiple consecutive new samples using pre-programmed settings. If Always Start On Next is activated, the sample settings in place at that time will be saved to the UPAS. At every power on event following activation of Always Start On Next, the UPAS will automatically initiate a new sample with the settings saved to the UPAS.

- **Set Date/Time:** The UPAS LED will flash blue repeatedly until the set future start date/time is reached. The UPAS will then initiate the pre-programmed sample automatically. The UPAS must remain on while waiting to start at the programmed date and time. Do not power the UPAS off while it is flashing blue.

Application note: This feature allows multiple UPAS to be programmed to all start sampling at the same time.

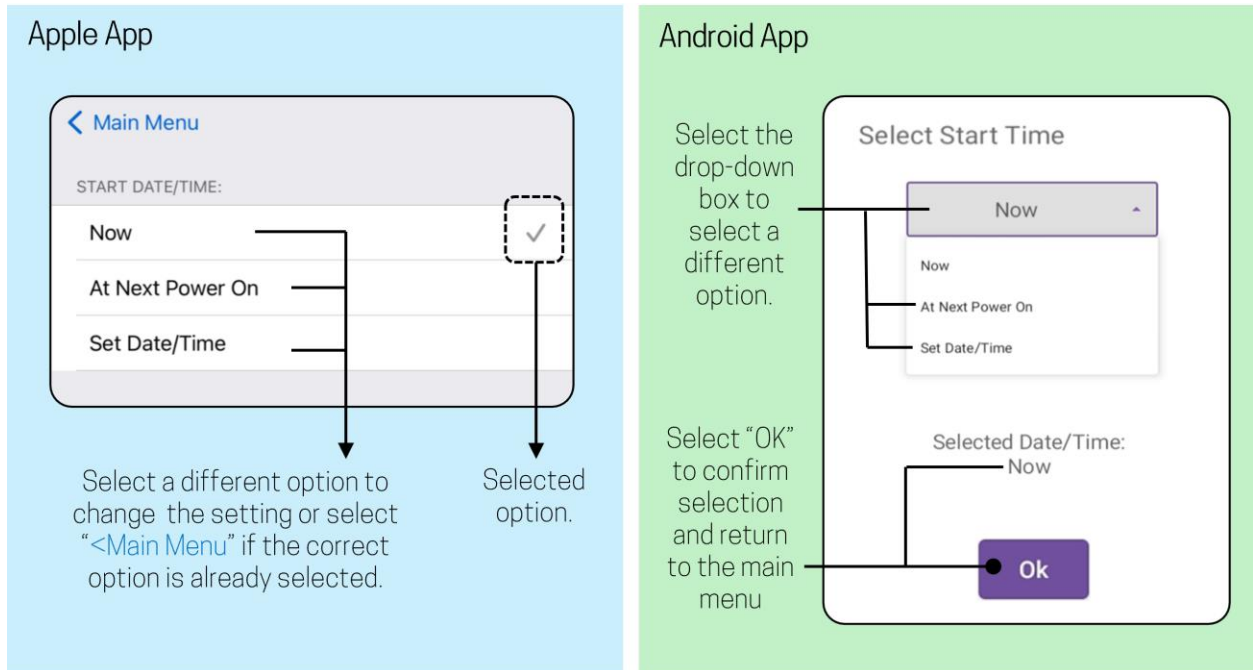

Figure 22. “Start Time” setting options in the App. Key components and instructions are identified for Apple (left) and Android devices (right).

Table 7. Sample start sequence when the sample Start Time is set to Now, At Next Power-On, and Set Date/Time.

	Step	LED status	Description
Now	Sample initiating	One orange LED flash then a red LED on	Pre-programmed sample is initiating, pumps will start soon and will adjust to the flow rate setpoint.
	Sample running	Green LED on (or blue LED on if charging during sample)	The UPAS is controlling the flow rate to the setpoint corresponding to the user-selected filter inlet.
At Next Power-On	Waiting for next power on	LED off	UPAS off. Awaiting the next power on via the UPAS pushbutton to initiate the pre-programmed sample.
	Power on with pushbutton	Green LED on	User powered on the UPAS with the pushbutton
	GPS initiating	Orange LED on	GPS initiating (applies whether GPS is on or off for the sample)
	Battery SOC status	Battery SOC sequence flashes once (twice if charging when powered on).	The current battery level when the UPAS initiates the sample.
	Sample initiating	One orange LED for 5 seconds then a red LED on	Pre-programmed sample is initiating, pumps will start soon and will adjust to flow rate setpoint.
	Sample running	Green LED on (or blue LED on if charging during sample)	The UPAS is controlling the flow rate to the setpoint corresponding to the user-selected filter inlet.
Set Date/Time	Saving sample settings	One orange LED flash, and one red LED flash.	Pre-programmed settings are saved.
	Waiting for start date/time	Blue LED flashes repeatedly	Awaiting the scheduled start date/time to initiate the pre-programmed sample.
	Pre-programmed sample settings	Blue LED on	Pre-programmed sample settings are initiating.
	Flow rate control initiating	Red LED on ¹	Filter pumps start and will adjust to the flow rate setpoint.
	Sample running	Green LED on (or blue LED on if charging during sample)	The UPAS is controlling the flow rate to the setpoint corresponding to the user-selected filter inlet.

1. If the UPAS is within 4% of its target flow rate when the pumps initiate, the **red** LED will be skipped.

Sample Duration

When the sample is started from the main menu, each option shown in **Figure 23** will have the effect described below.

- **Indefinite:** The sample will run until the user manually powers the UPAS off with the pushbutton OR the battery is depleted, as indicated by a battery voltage less than 2.8 V.
- **Set Duration:** The sample will run for the set duration of time, in hours and minutes. The UPAS will automatically power off when the sample duration has expired.

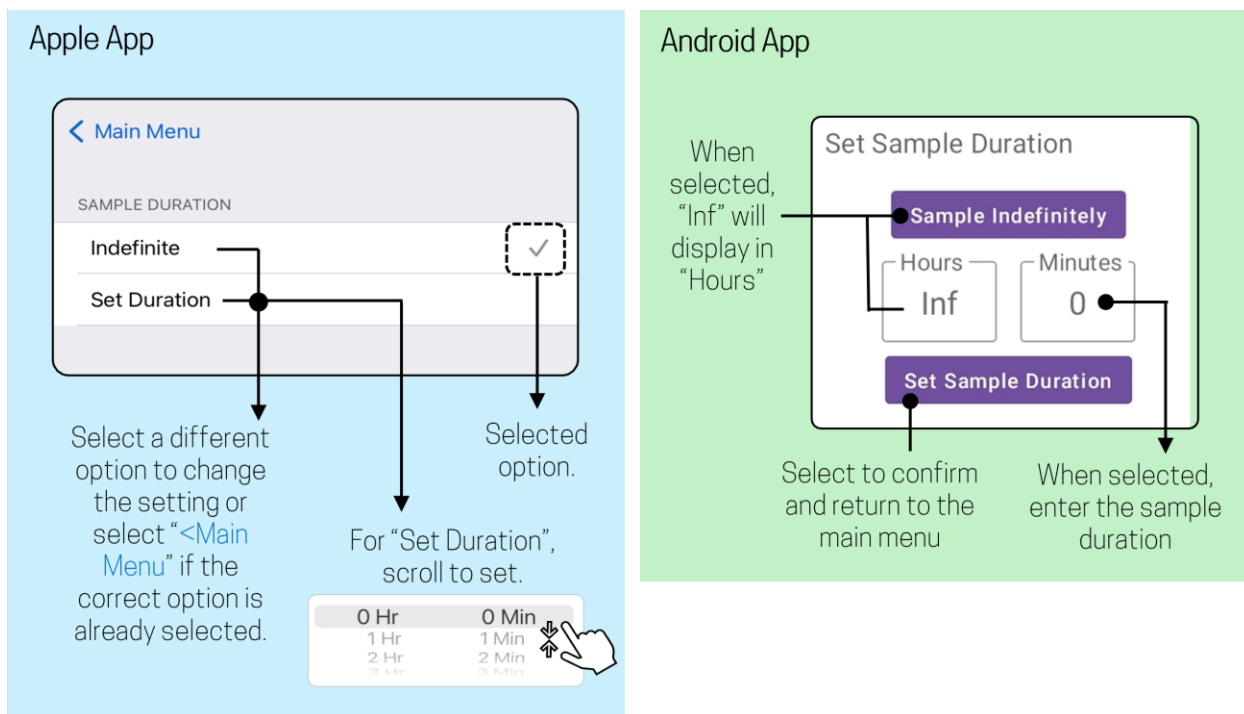

Figure 23. "Sample Duration" setting options in the app. Key components and instructions are identified for Apple (left) and Android devices (right).

Filter Inlet

Five filter inlet options are available (**Figure 24**). Select the option corresponding to the size-selective inlet that will be used to collect the sample. Refer to **Figure 7** to identify the different size-selective inlets visually. The selection made here will set the volumetric flow rate for the sample.

- **No Flow Sample:** The UPAS will not pump air through the inlet or filter; no PM will be collected. This setting can be used to start a sample with only the time-resolved sensors running.
- **PM2.5-1.0 LPM (black):** Air sample flow rate is set to 1.0 L min⁻¹. This setting is applicable for both GEN1 and GEN2 PM_{2.5} 1.0 L min⁻¹ inlets.
- **PM2.5-2.0 LPM (green):** Air sample flow rate is set to 2.0 L min⁻¹.
- **PM10-2.0 LPM (gold):** Air sample flow rate is set to 2.0 L min⁻¹.
- **PM Respirable-2.0 LPM (purple):** Air sample flow rate is set to 2.0 L min⁻¹.

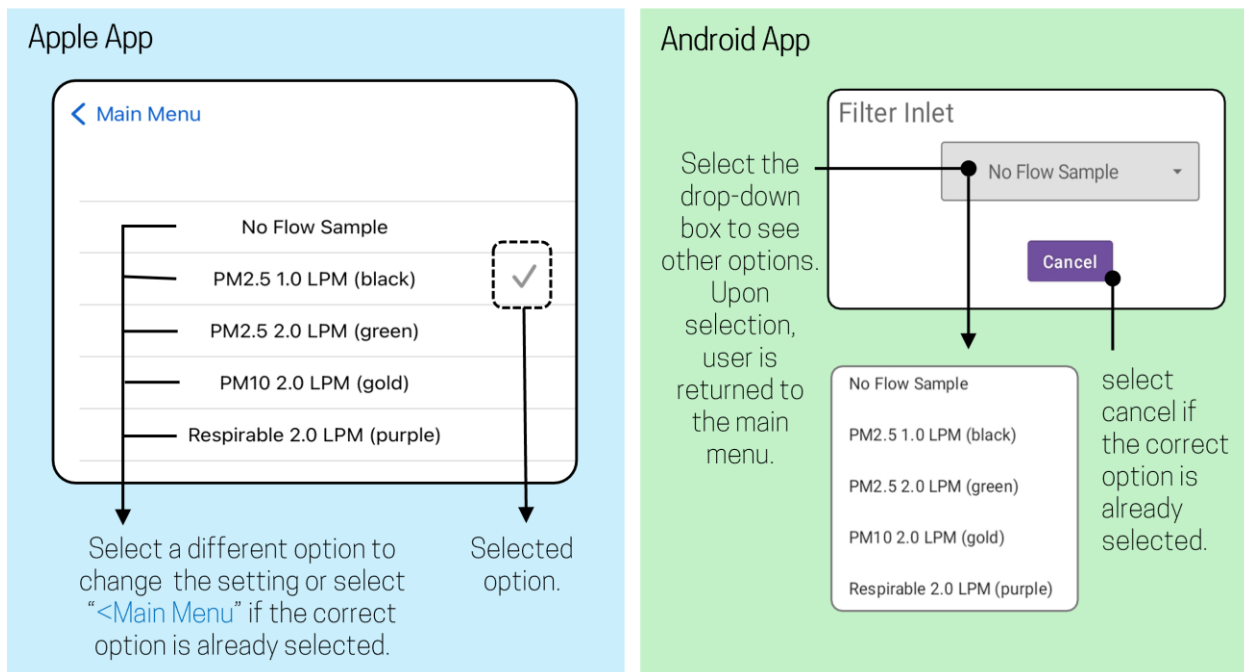

Figure 24. “Filter Inlet” settings in the app. Key components and instructions are identified for Apple (left) and Android devices (right).

Filter Flow Check & Adjust

You can check the UPAS filter sample flow rate against an external flow rate meter during sample programming and, if needed, make minor adjustments to the flow rate to minimize the difference between the target and the value measured with your flow meter. Use of this feature is optional and depends on the availability of a UPAS-compatible reference flow meter as well as the user’s sample quality assurance protocol. AST recommends verifying the UPAS volumetric flow rate regularly, relative to an external reference flow rate meter, as prescribed by the sampling method or protocol being used. Ensure that the flow meter being used is within its prescribed calibration interval.

To check the filter sample flow rate, install the same type of filter that will be used for the actual sample in the UPAS filter cartridge. This filter can be the actual filter that will be used to collect the sample or a test filter that will be disposed of, depending on your method or protocol. After installing the filter, cartridge, and size-selective inlet, seal the flow check adapter over the size-selective inlet and connect the adapter to the external flow meter as shown in **Figure 16**. Review the Size-Selective Inlet User Guide for detailed instructions on using flow check accessories.

The following instructions are summarized at the top of the “Filter Flow Check & Adjust” screen for quick reference.

First, activate flow by tapping the toggle switch in the iOS app or the “off” text in the Android app (**Figure 25**). When flow is activated, the UPAS pushbutton LED will flash white; then, the filter pump will turn on and target the flow rate corresponding to the size-selective inlet that was selected under the “Filter Inlet” setting. While the flow rate is attempting to reach the set point and stabilize, the UPAS LED will remain solid white; when the UPAS thinks the flow rate is within 5% of the target value, the LED will turn solid green. See the example in **Figure 26**.

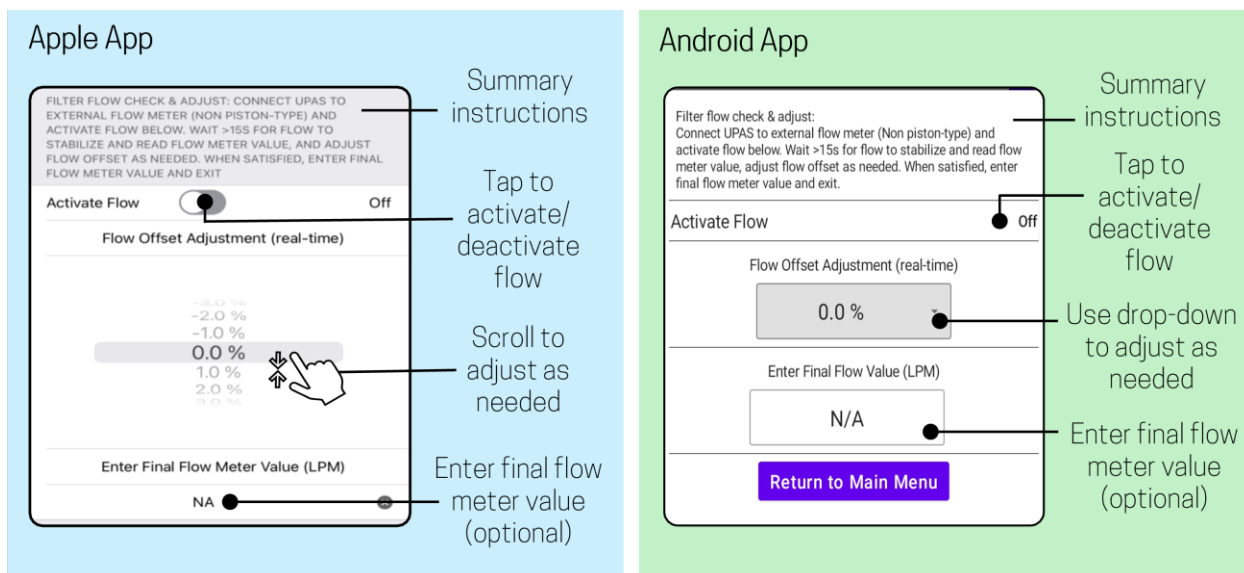

Figure 25. “Filter Flow Check & Adjust” screen in the App. Key components and instructions are identified for Apple (left) and Android devices (right).

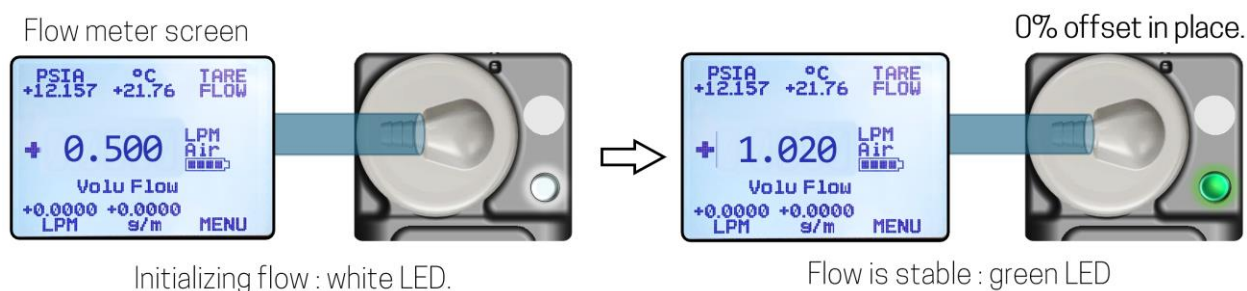
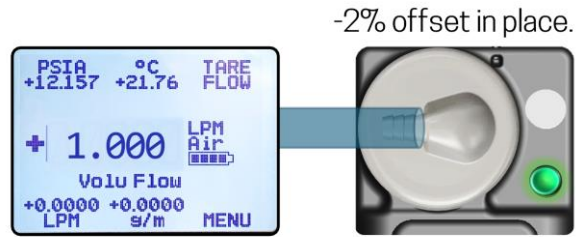

Figure 26. An example of the flow initialization sequence that occurs when the “Filter Flow Check & Adjust” feature is used. In this example, the target flow rate is set to 1.0 L min⁻¹. The external flow meter is represented by only the screen in this figure.

Next, observe the flow rate measured by the external meter. Compare this value to your target value and the tolerance allowed by your sampling protocol.

Optional: If you wish to apply a flow offset to try to achieve a sample flow rate closer to the target value, use Equation 1 to estimate the flow offset (%) needed to minimize the difference between the volumetric flow rate required by the size-selective inlet (“target flow rate;” either 1 or 2 L min⁻¹) and the flow rate measured by your external meter (“measured flow rate;” L min⁻¹). Then, while the pumps are running, adjust the flow offset in the app to the whole-number value that is closest to the flow offset calculated using Equation 1. When the adjustment is made in the app, the UPAS will automatically start adjusting the flow rate. The UPAS LED may show white while the UPAS adjusts. Wait for the solid green LED, which indicates that the flow is stable, and observe the external flow meter measurement to confirm that the difference between the target flow rate and the measured value has been minimized (**Figure 27**). If further adjustment is needed, use Equation 1 to continue adjusting the flow offset, in an iterative manner, until the flow rate is sufficiently close to the target value for your sampling protocol.

$$\text{Flow offset} = \frac{\text{Target flow rate} - \text{Measured flow rate}}{\text{Target flow rate}} * 100 \quad \text{Eq. (1)}$$



Flow is stable : green LED

Figure 27. An example of stable flow after setting a -2% flow offset using the “Filter Flow Check & Adjust” feature in the app. The flow offset minimizes the difference between the target flow and the measured flow to 0% in this example. The external flow meter is represented by only the screen in this figure.

Optional: At the bottom of the screen, enter the final flow rate ($L \text{ min}^{-1}$) measured using the external meter with the selected flow offset in place. This value will be recorded in the sample log file. This value is recorded for your reference only. Entering or choosing not to enter this value does not affect UPAS operation in any way.

Deactivate the flow and return to the main menu. Disconnect the flow check adapter and external flow rate meter from the UPAS.

Note the UPAS will not log any sample data while the filter flow check is in progress. Do not collect actual samples with the filter flow activated via the flow check screen.

Filter Flow Duty Cycle

Use filter flow duty cycle to set the filter flow pumps to sample for just a fraction of every 30 second interval during the sample. Duty cycle options of 1% to 100% are available (**Figure 28**). The default value is 100% (i.e., the filter pump samples at the target flow rate 100% of the time for the duration of the sample). The purpose of reducing the duty cycle below 100% is to reduce the amount of PM mass collected (to reduce the risk of inlet and/or filter overloading) or to extend the UPAS internal battery life over the user’s desired sample duration. Note that reducing the duty cycle below 100% will reduce the total volume of air sampled, and thus the total mass of PM sampled, over the sample duration. This outcome may or may not be desirable, depending on the application.

Use Equation 2a and 2b to calculate the number of seconds the filter pump will be on and off, respectively, within each 30-second interval during the sample:

$$\text{Filter pump on (sec) per 30s interval} = 30 \text{ s} \left(\frac{\text{Filter Flow Duty Cycle \%}}{100} \right) \quad \text{Eq. (2a)}$$

$$\text{Filter pump off (sec) per 30s interval} = 30 \text{ s} - \text{Filter pump on (s) per 30 sec interval} \quad \text{Eq. (2b)}$$

For example, with the duty cycle set to 100%, the filter pump will remain on and sample continuously until the sample duration expires. With the duty cycle set to 50%, the filter pumps will turn on for 15 seconds and off for 15 seconds, then repeat this sequence until the sample duration expires.

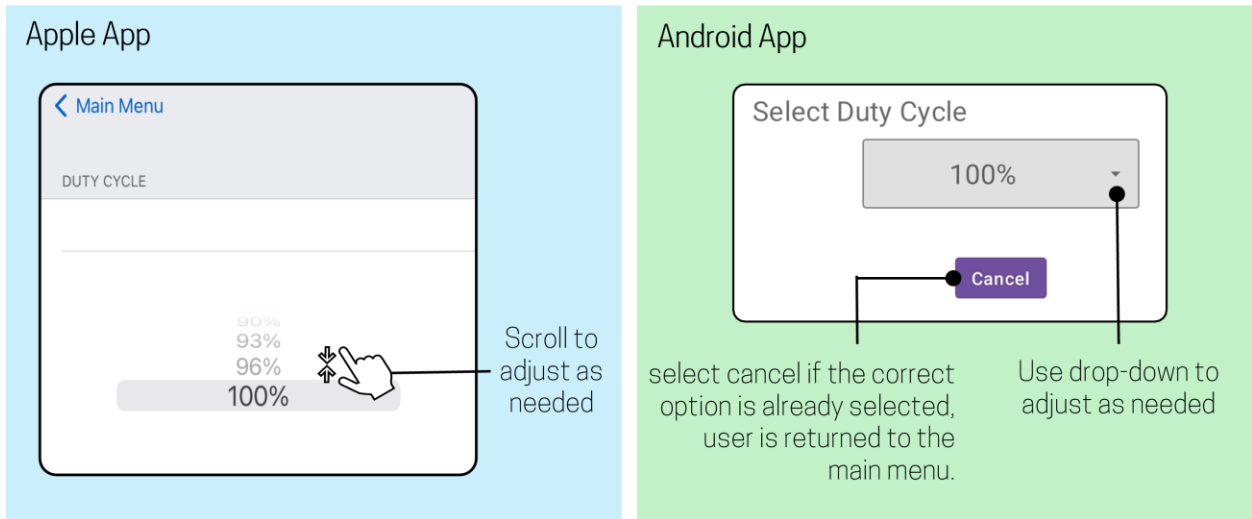

Figure 28. “Filter Flow Duty Cycle” screen in the App. Key components and instructions are identified for Apple (left) and Android devices (right).

PM Sensor Operation (v2.1 PLUS only)

The time-resolved optical PM sensor (Sensirion SPS30) housed inside the UPAS v2.1 PLUS can be set to operate in any one of the 19 modes listed in the “PM Sensor Operation” submenu (**Figure 29**).

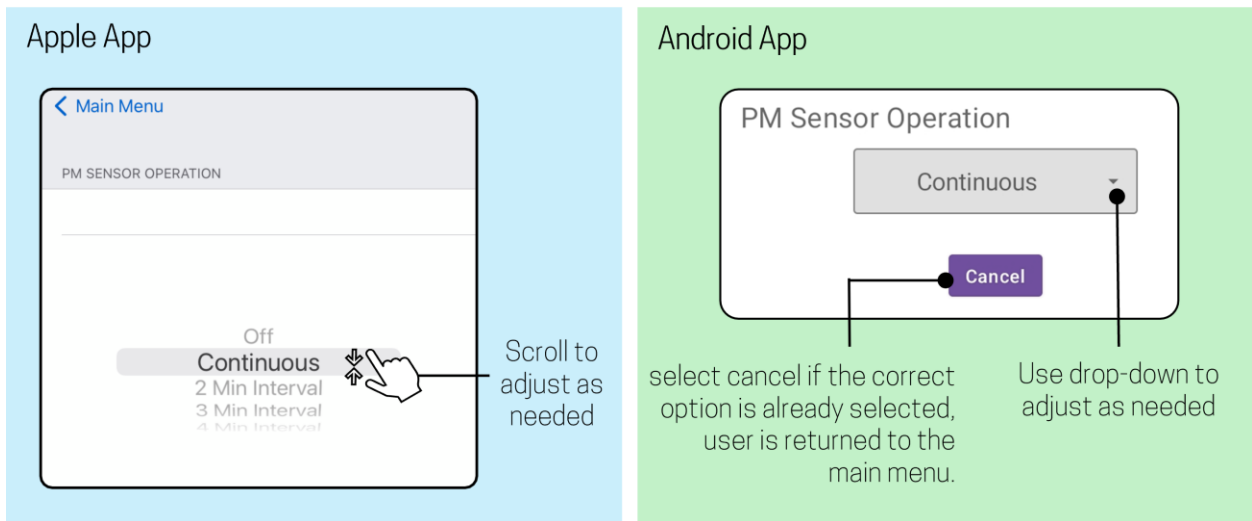

Figure 29. “PM Sensor Operation” mode screen in the App. Key components and instructions are identified for Apple (left) and Android devices (right).

The PM-sensor power consumption is significant relative to the total UPAS power consumption during a sample; different PM-sensor modes allow the user to balance the need for time-resolved PM measurements against the required sample duration (as limited by the internal UPAS battery capacity). Select the mode best suited to your protocol and use model.

When the sample is started from the main menu, each mode will have the following effect:

- **Off:** PM sensor disabled for the duration of the sample.
- **Continuous:** PM sensor remains on continuously and logs data at the sample log interval.

- **2 to 15 Min Interval:** PM sensor operates intermittently for the duration of the sample. For example, a 5-minute interval consists of a 30-s warm-up, followed by 30-s measurement, followed by 4-minute sleep period (30s + 30s + 4 min = 5 minutes); then, the sequence repeats.
- **15s-5s-10s Interval:** PM sensor operates intermittently for the duration of the sample. The sequence starts with a 15-s warm-up, followed by 5-s measurement, followed by 10-s sleep period; then, the sequence repeats.
- **15s-5s-40s Interval:** PM sensor operates intermittently for the duration of the sample. The sequence starts with a 15-s warm-up, followed by 5-s measurement, followed by 40-s sleep period; then, the sequence repeats.
- **20s-10s-30s Interval:** PM sensor operates intermittently for the duration of the sample. The sequence starts with a 20-s warm-up, followed by 10-s measurement, followed by 30-s sleep period; then, the sequence repeats.

If “Power Save” mode is on, the PM-sensor mode is automatically set to “15 Min Interval” between 9 PM and 4 AM local time. Note that the UPAS operates in and logs data with UTC time as the primary timestamp. The UPAS UTC time will always be correct, because the UPAS obtains the UTC time from GPS satellites. The UPAS assumes the local time zone is the time zone to which the mobile device used to program the UPAS sample was set at the time the sample was programmed. If the UPAS is moved to a different time zone after the sample is programmed, the local time zone assumed by the UPAS will not be updated.

CO₂ Sensor

On the UPAS v2.1 PLUS, a time-resolved CO₂ sensor (Sensirion, SCD41-D-R2) is housed near the outlet of air path 2 (**Figure 3**). The Sensirion SCD41 is a photoacoustic sensor with a measurement range of 400 to 5,000 ppm.

The CO₂ sensor can be turned on or off. When on, CO₂ concentrations (ppm) measured using the sensor are written to the UPAS sample log at the specified log interval.

CO₂ Sensor Calibration

Use the app to calibrate the CO₂ sensor outdoors, in an environment where a stable CO₂ concentration is being measured by a reference instrument, or against a calibration gas with a known CO₂ concentration. Calibrate the CO₂ sensor closer to the sample start time for the best results.

To calibrate the CO₂ sensor against outdoor air, take the UPAS outdoors and place it at least 10 feet (~3 meters) from CO₂ sources (including humans); then, set the “Target CO₂ Concentration (ppm)” to 417 ppm. When calibrating in another environment, set the “Target CO₂ Concentration (ppm)” to the known CO₂ concentration. Start the CO₂ sensor calibration in the app. The UPAS disconnects from the app once the calibration starts and connection to a mobile device is not needed to complete the calibration (**Figure 30**).

Wait 15 minutes for the CO₂ calibration to complete. During the calibration, the UPAS LED will flash orange. When the calibration is complete, the UPAS will automatically power off and store the CO₂ calibration information, which can be viewed in the sample log file.

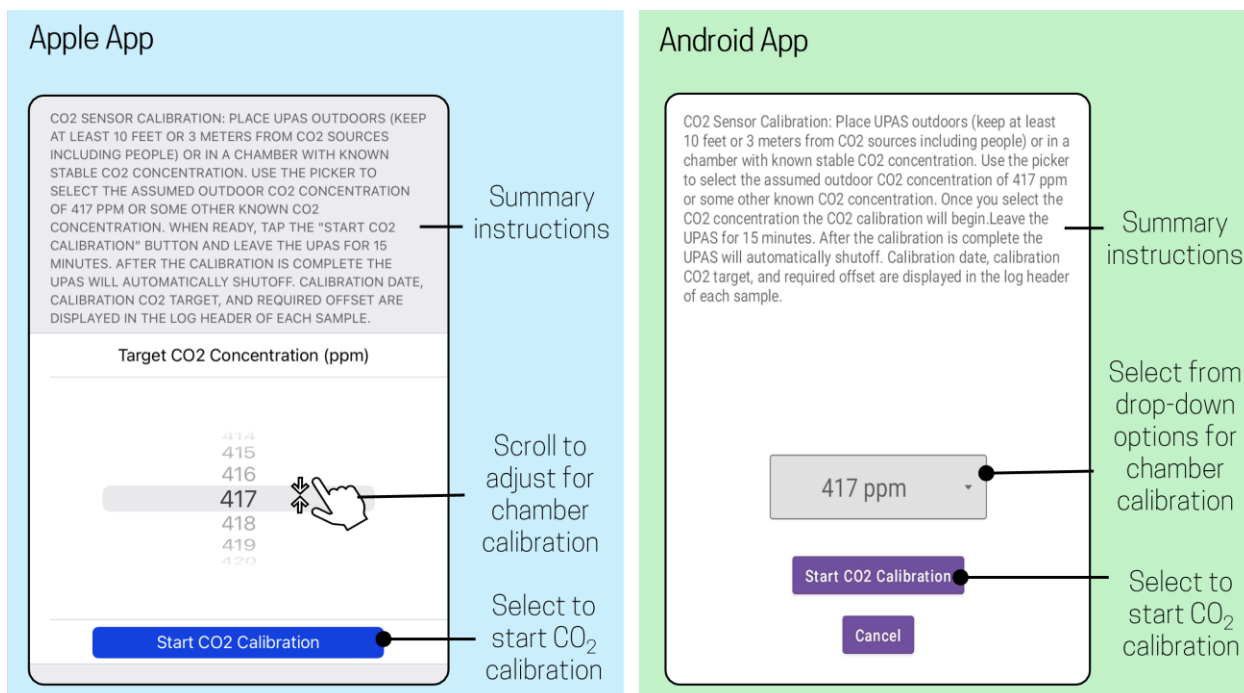

Figure 30. “CO2 Sensor Calibration” screens in the Apple (left) and Android (right) apps with key items identified.

VOC/NO_x Sensor

On the UPAS v2.1 PLUS, a Sensirion SGP41 metal-oxide VOC/NO_x sensor is housed near the outlet of air path 2 (**Figure 3**). The SGP41 provides one qualitative estimate of the VOC level and one qualitative estimate of the NO_x level. The VOC/NO_x sensor can be turned on or off. When on, VOC and NO_x estimates from the sensor are written to the UPAS sample log at the specified log interval.

GPS

The GPS module can be turned on or off. When on, latitude, longitude, altitude, and speed data are written to the sample log at each log interval for which the UPAS can obtain a GPS signal.

Even when the module is on, the UPAS might not be able to receive a GPS signal inside some buildings. The GPS signal is strongest outdoors with a clear view of the sky. The UPAS will start the sample regardless of whether it has a GPS signal. Even if the UPAS cannot obtain a GPS signal at the start of the sample, if the GPS module is set to “on,” the UPAS will log latitude, longitude, altitude, and speed data if/when it is moved to a location where it can obtain a GPS signal later during the sample.

GPS data from the UPAS are only stored in the log file. The app does not store location data.

LED

The UPAS LED can be set to remain on or to turn off during active sampling. Refer to **Table 6** to interpret the colors that will be displayed if the LED is on during sampling. If the “off” setting is selected, the LED will turn off once the sample has started and the UPAS has reached the flow rate setpoint but will turn back on if the UPAS is charging while sampling or to display an error (e.g., blocked flow). Regardless of this setting, the LED will also turn on when the UPAS is first turned on, is progressing through the power-on sequence (see **Table 5**), and is connected to the app.

Power Save

“Power Save” mode can be turned on or off. When on, between 9 PM and 4 AM local time, the PM sensor operation mode will automatically be set to “15 Min Interval”, and the GPS will be turned off.

Note that the UPAS operates in and logs data with UTC time as the primary timestamp. The UPAS UTC time will always be correct, because the UPAS obtains the UTC time from GPS satellites. The UPAS assumes the local time zone is the time zone to which the mobile device used to program the UPAS sample was set at the time the sample was programmed. If the UPAS is moved to a different time zone after the sample is programmed, the local time zone assumed by the UPAS and used to implement power save mode will not be updated.

Log Interval

There was a point at which the sample log interval could be set to 30 s or 1 s using either the iOS or Android app. The 1-s logging option is no longer available in Android app version 2.3.1 (released March 27, 2025) or iOS app version 1.1.2 (released May 22, 2025). Users who wish to log UPAS data at 1-s intervals will need to update their UPAS to firmware version 200.

We strongly recommend using a 30-second logging interval. If you are considering using a 1-second logging interval, review the following important notes first:



- Depending on the sample duration, the log file created may be very large in size and hard to open using a computer or mobile device.
- Large log files will require more computing power during data processing.
- The UPAS battery runtime will be reduced substantially when the log interval is 1 s.

Monitor Config

Two options are available for the “Monitor Config”: personal and stationary. The monitor configuration will be stored in the log file header for the sample. This feature can be used to distinguish between stationary and personal samples during log file analysis. This setting only affects the “personal” or “stationary” tag written on the “SamplerConfiguration” line in the log file header (see **Table 9**) and has no bearing on any other sample settings or on UPAS operation.

Motion and light sensors

The motion and light sensors are always on and cannot be turned off in the app. Data from these sensors will be logged at the programmed log interval when a sample is running.

Start the sample

Confirm all settings are configured correctly, then select “Start” from the top right corner of the app main menu. A pop-up box will display the message “Configuration Complete!” The UPAS will then disconnect from the app and mobile device automatically. Your sample settings will no longer appear in the app main menu once the UPAS has disconnected, but they have been saved to the UPAS.

What the UPAS does immediately after disconnecting from the app will depend on how the sample start time was programmed. If the start time was set to “Now,” the UPAS will start the sample

immediately; if the start time was set to “At Next Power On,” the UPAS will turn off; if the start time was set to a specific date and time, the UPAS will go into a low-power idle mode until that date/time is reached. Different LED colors will indicate the UPAS status; see **Table 7** to determine the meaning of each color.

App lock to hold sample settings (optional)

The “app lock” feature prevents the user from changing some sample settings without a special command. Before implementing app lock, select all desired sample settings except for the sample name. Activate the lock by entering “APLOCK#” into the sample name field and return to the main menu. Power cycle the UPAS using the pushbutton and reconnect to the UPAS with the app. When reconnected, the following settings will be locked and greyed out so the user cannot change them:

- Filter Inlet
- Filter Flow Duty Cycle
- PM Sensor Operation (UPAS v2.1 PLUS only)
- CO2 Sensor (UPAS v2.1 PLUS only)
- VOC/NOX Sensor (UPAS v2.1 PLUS only)
- GPS (on or off)
- LED (on or off)
- Power Save
- Log Interval

The following settings will remain unlocked:

- Sample Name
- Cartridge ID
- Start Time
- Sample Duration
- Filter Flow Check & Adjust
- CO2 Sensor Calibration (UPAS v2.1 PLUS only)
- Monitor Config

The UPAS will remain locked, throughout subsequent power cycles, until it is unlocked using the app. To unlock the settings, connect to the UPAS with the app, enter “APOPEN#” into the sample name field, and return to the main menu. Power cycle the UPAS using the pushbutton and then reconnect to the UPAS with the app. When reconnected, all app settings will be available to configure.

Special operating modes

The special operating modes described below are *not* activated by default. The following sections contain information on: (a) situations where these modes are useful and (b) how to activate them.

Each mode can be activated by connecting the UPAS to the mobile app, entering the activation code from **Table 8 Table 1** in the sample name field, and then hitting “return” (on an iOS device) or “Ok” (on an Android device). At that point, the app will return to the main menu, the code will disappear from the sample name field and the mode will have been activated.

Table 8. Special operating modes that can be activated and deactivated by entering the specified codes into the sample name field while a UPAS is connected to the mobile app.

Mode	Activation code	Deactivation code
External power mode	EXTPOW#	BATTCK#
Always start on next power-on	ASON#	Not applicable; see the Always start on next power-on section below for instructions on how to deactivate this mode.

“External power mode” can be deactivated by connecting the UPAS to the mobile app, entering BATTCK# **Table 1** in the sample name field, and then hitting “return” (iOS) or “done” (Android). The app will return to the main menu, the code will disappear from the sample name field and the mode will have been deactivated. See the **Always start on next power-on** section below for instructions on how to deactivate this mode.

External power mode

“External power mode” should be activated if you plan to sample with the UPAS plugged into an external battery pack or a wall outlet. When the UPAS is in external power mode, it will progress all the way through the power-on sequence and become available to connect to the app (solid pink LED) when powered on while plugged-in to a charging source. In other words, external power mode causes the UPAS to skip the repeating battery SOC LED sequence when the UPAS is powered-on while charging. If the UPAS is not in external power mode and is powered on while plugged-in to a charging source, the UPAS will need to be unplugged from the charging source before it will progress all the way through the power-on sequence and become available to connect to the app over Bluetooth.

When external power mode is active, if the UPAS is receiving power from a charging source when powered-on, the battery SOC status LED(s) will flash two times before the UPAS proceeds to the next step in the power-on sequence.

Application note: If you are activating external power mode because you are charging the UPAS with an external battery pack while sampling, the external battery pack must be operated in “always-on” mode. See the Using external battery packs section above for additional information.

Always start on next power-on

“Always Start On Next Power On” (ASON) mode is designed to allow an individual to collect multiple consecutive samples with a UPAS without needing to program the sample settings using the app before each sample. For example, ASON mode can be used in a deployment strategy in which a member of a research team pre-programs a UPAS before delivering it to a study participant and then the study participant uses the UPAS to collect multiple PM samples. The participant might need to change out filter cartridges on a pre-determined schedule but will not have to worry about downloading the app or programming the sample settings.

In ASON mode, all sample settings are saved when the sample is programmed using the app and every time the UPAS is powered-on after ASON mode is activated, a sample initiates automatically using the pre-programmed settings. In ASON mode, there is no way to manually enter a unique sample name or cartridge ID for each sample run. A new log file, with a unique file name, is written each time

the UPAS turns on and starts a sample. Each log file written in ASON mode is identified by a unique auto-generated file name that includes the UTC timestamp when the sample started followed by a number equal to the lifetime sample count, the latter of which will increment by one every time the UPAS is powered-on and a sample initiates. When using ASON mode, consider that you may need to devise a plan to keep a separate written or electronic record of the dates and times when different filter cartridge IDs were installed and removed from the UPAS.

To use the UPAS in ASON mode, first configure the sample settings in the main menu as appropriate. Then activate, ASON mode as described above and in **Table 8**. When the “Start” button in the main menu is pressed after ASON mode has been activated, the UPAS will automatically disconnect from the app, power off, and await the next power-on event to start a sample.

If the UPAS is programmed to sample for a fixed sample duration and in ASON mode, the countdown to the end of the sample duration will restart from zero each time the UPAS is powered on, even if the UPAS was powered off unintentionally before the sample ran to completion.

To deactivate ASON mode, remove the microSD card and then power-on the UPAS. Wait for the LED to flash orange. Press the pushbutton 7× until the LED flashes pink, then reinstall the microSD card and wait for the LED to turn solid green. Finally, turn the UPAS off and then back on; it should proceed through the power-on sequence and become available to connect to the app (solid pink LED).

5 UPAS Log File

Accessing log files

Remove the microSD card from the UPAS and insert it into a computer. Use a microSD-to-SD or microSD-to-USB adapter if needed. Navigate to the microSD card storage on the computer. The log files (comma-separated .txt file format) will be organized in dated folders and each log file name will contain the identifiers outlined in **Figure 31**.

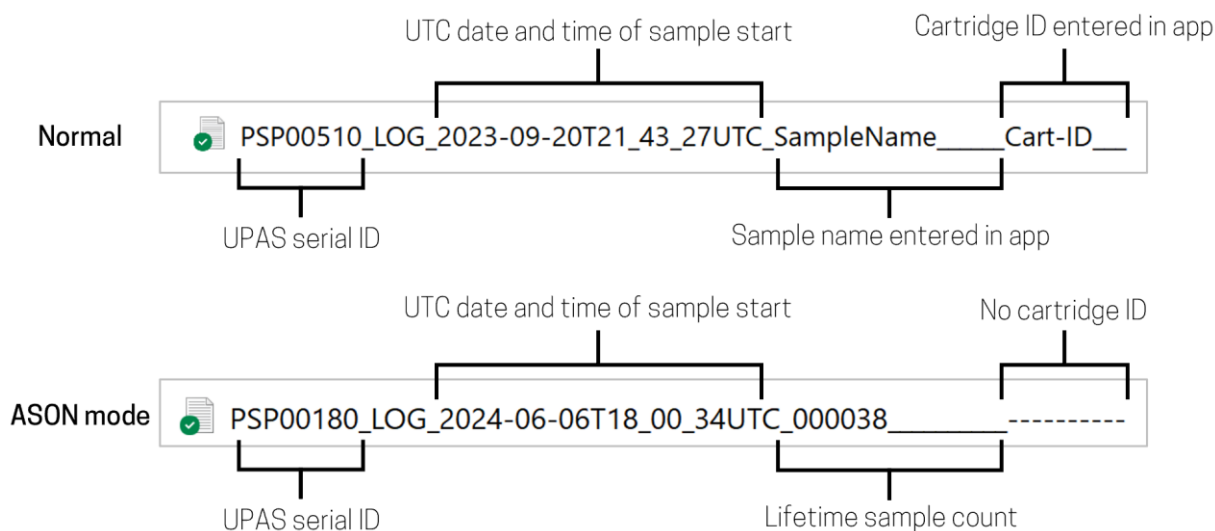

Figure 31. Key identifiers in each UPAS log file name for samples collected during normal operation (top) and in “Always Start On Next” mode (bottom).

In “Always Start On Next” mode (**Section 4**), a new log file will be generated automatically at each power-on event. Each log file will be identified by the date and time when the sample started and by the incrementing lifetime sample count, the latter of which will appear in place of the sample name.

Log file legend

Each log file starts with a header that is organized into six sections:

- 1 Device Information
- 2 Sample Identification
- 3 Setup Summary
- 4 Sample Summary
- 5 CO2 Sensor Calibration (v2.1 PLUS only)
- 6 Mass Flow Sensor Calibration

Refer to **Table 9** for a description of each variable in the header. The header is followed by the sample log. In the sample log, timestamped variable outputs are recorded at the set logging interval. The sample log data are organized into the nine categories described in **Table 10**. Refer to **Table 11** for a detailed description of each variable in the sample log.

Table 9. Description of sample log header data variables, organized by section.

	Parameter	Format/Units	Description
Device Information	UPASserial	(-)	UPAS serial number
	UPASpcbRev	(-)	Main PCB revision number
	UPASexpRev	(-)	Expansion PCB revision number (OBR2, OBR0, OCRO, or NA if no expansion board installed)
	MotionID	(HEX ID)	0x6B=LSM6DSRX 0x6C=LSM6DSOX
	PMserial	ID_FWver_HWrev_SHDLCver	Sensirion SPS30 particulate matter sensor serial number
	CO2serial	(HEX ID)	Sensirion SCD4x CO2 sensor serial number
	Gasserial	(HEX ID)	Sensirion SGP41 VOC and Nox sensor serial number
	UPASfirmware	(-)	Current version of firmware running on the UPAS
	LifetimeSampleCount	(integer)	Number of samples started in the lifetime of the UPAS
	LifetimeSampleRuntime	(h)	Cumulative sample hours in the lifetime of the UPAS
	LifetimeBatteryRuntime	(h)	Cumulative hours that the battery has operated. (Any hours of operation that occurred prior to Sept 16, 2022 are not accounted for.)
	LifetimeSamplePumptime	(h)	Cumulative hours that the pumps have operated. (Any hours of operation that occurred prior to Sept 16, 2022 are not accounted for.)
	LifetimePMSensorFanStartCount	(#)	Cumulative counts that the SPS30 fan has started. (Any hours of operation that occurred prior to Sept 16, 2022 are not accounted for.)
	LifetimePMSensorFanHours	(h)	Cumulative hours that the SPS30 fan has operated. (Any hours of operation that occurred prior to Sept 16, 2022 are not accounted for.)
	Sample Identification	LifetimePMSensorPMMC	(mg)
LifetimeCO2SensorHours		(h)	Cumulative hours that CO ₂ sensor has operated. (Any hours of operation that occurred prior to Sept 16, 2022 are not accounted for.)
LifetimeVOCSensorHours		(h)	Cumulative hours that VOC sensor has operated. (Any hours of operation that occurred prior to Sept 16, 2022 are not accounted for.)
Setup Summary	LogFilename		Log filename as saved on the microSD card (automatically defined)
	SampleName		Sample name entered by the user into the mobile application
	CartridgeID		Cartridge identifier entered by the user into the mobile app
	GPSUTCOffset	(h)	UTC offset for local time zone
	StartOnNextPowerUp	(integer)	Was the UPAS programmed to start on next power-on? (0 = no, 1 = yes, 2 = system reset, 4 = always start on next)
Setup Summary	ProgrammedStartTime	(s)	0 = "now" or "start on next power up"; otherwise equal to seconds since 1/1/1970
	ProgrammedRuntime	(s)	Programmed sample run time; 360000000 means "indefinite"
	SizeSelectiveInlet	(-)	PM size fraction collected by the inlet installed on the UPAS

	FlowRateSetpoint	(L min ⁻¹)	Programmed volumetric flow rate
	FlowOffset	(%)	The flow offset selected in the mobile app (% of the target)
	FlowDutyCycle	(%)	Duty cycle (possible values range from 13% to 100% in 3% or 4% increments)
	DutyCycleWindow	(s)	Period of duty cycle (30 s)
	GPSEnabled	0 or 1	GPS status during the sample; 0 = disabled, 1 = enabled
	PMSensorInterval	integer between 0 and 18	0 = sensor disabled; 1 = continuous measurement; 2-15 = intermittent measurement interval in minutes (e.g., 5 = 30-s warm-up, followed by 30-s measurement, followed by 4-minute sleep period); 16 = 15-s warm-up, followed by 5-s measurement, followed by 10-s sleep period; 17 = 15-s warm-up, followed by 5-s measurement, followed by 40-s sleep period; 18 = 20-s warm-up, followed by 10-s measurement, followed by 30-s sleep period
	RTGasSampleState	0 or 1	Status of Sensirion SGP41 VOC/NO _x sensor; 0 = off, 1 = on
	CO2SampleState	0 or 1	Status of Sensirion SCD41 CO ₂ sensor; 0 = off, 1 = on
	LogInterval	(s)	Interval at which data are written to the log file
	SamplerConfiguration	0 or 1	0=personal/mobile; 1=stationary This is only for metadata use to allow users to designate if a upas sample was worn by a subject or if the upas was setup to be a stationary monitor.
	ExternalPowerMode	0F or F0	0F = Off meaning that the battery SOC check will continue to cycle if UPAS is powered up while plugged into an external power source; F0 = On meaning that the battery SOC check cycle will not halt start on next power on samples or keep users from connecting to the UPAS using the BLE smartphone application.
	PowerSaveMode	0 or 1	0 = off, 1 = on; in power-save mode, the GPS is turned off and PMSensorInterval = 15 between 9 PM and 4 AM local time.
	AppLock	0, 1, or -1	Status of mobile application lock; 0 = unlocked, 1 = locked, -1 = not set (this feature is currently unavailable)
	AppVersion	i = iOS, A = Android	The version of the mobile application that was used to program the UPAS
Sample Summary	StartDateTimeUTC	(YYYY-MM-DDTHH:MM:SS) (UTC date time format)	Timestamp when sample started (coordinated universal time)
	StartDateTimeLocal	(YYYY-MM-DDTHH:MM:SS) (Local date time format)	Timestamp when sample started, displayed in the timezone on the mobile device used to program the UPAS
	EndDateTimeUTC	(YYYY-MM-DDTHH:MM:SS) (UTC date time format)	Timestamp when sample ended (coordinated universal time)
	EndDateTimeLocal	(YYYY-MM-DDTHH:MM:SS) (Local date time format)	Timestamp when sample ended, displayed in the timezone on the mobile device used to program the UPAS

	FlowCheckMeterReadingPreSample	(L min ⁻¹)	The external flow meter reading entered into the mobile application by the user during the manual pre-sample check (if applicable; a pre-sample flow check is not required)
	FlowCheckMeterReadingPostSample	(L min ⁻¹)	The external flow meter reading entered into the mobile application by the user during the manual post-sample check (this feature is currently unavailable)
	OverallDuration	(h)	Overall sample log duration
	PumpingDuration	(h)	Overall duration for which the pumps pulled air through the sample filter
	OverallFlowRateAverage	(L min ⁻¹)	Sample-averaged flow rate through the filter as calculated with our factory flow calibration curve shifted by the user-applied flow offset.
	PumpingFlowRateAverage	(L min ⁻¹)	Sample-averaged flow rate through the filter when the pumps were on as calculated with our factory flow calibration curve shifted by the user-applied flow offset.
	SampledVolume	(L)	Volume of air sampled through the filter as calculated with our factory flow calibration curve shifted by the user-applied flow offset.
	PercentTimeWorn	(%)	Estimated percent of a sample that the UPAS was worn during a sample. This is calculated based on a rolling average using the AccelXVar, AccelYVar, and AccelZVar. If any of these three values are greater than 100 during a 10-minute period motion is considered detected during that period. This estimate will not be reliable when sampling at 100% duty cycle with a UPAS for which UPASexpRev is not "OBR2" because acceleration will be detected due to sample pump operation even if the UPAS is stationary; in such a situation, we recommend using the StepCount variable in the sample log to evaluate whether the UPAS was in motion.
	StartBatteryCharge	(%)	Battery state of charge when the sample started
	EndBatteryCharge	(%)	Battery state of charge when the sample ended
	StartBatteryVoltage	(V)	Battery voltage when the sample started
	EndBatteryVoltage	(V)	Battery voltage when the sample ended
	ShutdownMode	(integer)	0 = unknown error shutdown; 1 = user pushbutton sample stop; 2 = depleted battery shutdown (< 2.8 V); 3 = successfully completed preset sample duration; 4 = thermal protection shutdown; 5 = max power at initialization error; 6 = max pump voltage during sample shutdown; 7 = blocked flow during sample shutdown; 8 = SD card removed during sample; 64+ = freeze; 80+ = real-time operating system (RTOS) crash
	CO ₂ Sensor Calibration	CO2CalDate	(YYYY-MM-DDTHH:MM:SS) (UTC date time format)
CO2CalTarget		(ppm)	The target (i.e., reference) CO ₂ concentration during calibration (e.g., 417 ppm for calibration in outdoor air)
CO2CalOffset		(ppm)	The offset applied to make the CO ₂ sensor reading match CO2CalTarget

Mass Flow Sensor Calibration	MFSCalDate	(YYYY-MM-DDTHH:MM:SS) (UTC date time format)	The timestamp when the internal UPAS mass flow sensor was last calibrated
	MFSCalPerson	(-)	Name of the person who completed and approved the mass flow sensor calibration
	MFSCalVoutBlocked	(V)	Mass flow sensor output voltage measured when flow was blocked during calibration (currently unused)
	MFSCalVoutMin	(V)	Mass flow sensor output voltage measured at minimum flow during calibration
	MFSCalVoutMax	(V)	Mass flow sensor output voltage measured at maximum flow during calibration
	MFSCalMFBlocked	(g min ⁻¹)	Mass flow rate measured when flow was blocked during calibration (currently unused)
	MFSCalMFMin	(g min ⁻¹)	Minimum mass flow rate measured during calibration when the flow was unblocked
	MFSCalMFMax	(g min ⁻¹)	Maximum mass flow rate measured during calibration
	MFSCalPumpVBoostMin	(V)	Minimum pump voltage measured during calibration (currently unused)
	MFSCalPumpVBoostMax	(V)	Maximum pump voltage measured during calibration (currently unused)
	MFSCalPDeadhead	(Pa)	The pressure inside the pump manifold when the inlet was blocked and pumps were run at maximum power during flow calibration (currently unused)
	MF4	(-)	Coefficient of 4th-degree term in polynomial describing mass flow calibration curve
	MF3	(-)	Coefficient of 3rd-degree term in polynomial describing mass flow calibration curve
	MF2	(-)	Coefficient of 2nd-degree term in polynomial describing mass flow calibration curve
	MF1	(-)	Coefficient of 1st-degree term in polynomial describing mass flow calibration curve
MF0	(-)	Coefficient of 0th-degree term in polynomial describing mass flow calibration curve	

Table 10. Sample log data categories.

Sample Log Category	Description
DateTime	Timestamps
FilterSample	Data on the flow through the sample filter
Battery	The battery state of charge
Atmo	Data on altitude as well as air temperature, pressure, relative humidity, and density
GPS	Global Positioning System data
Motion	Data from the accelerometer
Light	Data from the light sensor
PMSensor	Data from the Sensirion SPS30 particulate matter sensor
EngData	Engineering data on the operational state of the UPAS; helpful for troubleshooting
Gas	Data from the Sensirion SCD41 CO ₂ sensor and the Sensirion SGP41 VOC/NO _x sensor

Table 11. Description of sample log data variables, organized by category.

	Variable	Format/Units	Description
Date Time	SampleTime	(HH:MM:SS)	Elapsed time since the UPAS flow rate reached a value within 4% of the setpoint
	UnixTime	(s)	Primary timestamp: Number of seconds that have elapsed since the Unix epoch (00:00:00 UTC on 1 January 1970, excluding leap seconds)
	UnixTimeMCU	(s)	Secondary timestamp: Number of seconds that have elapsed since the Unix epoch (we recommend using UnixTime instead of this timestamp)
	DateTimeUTC	(YYYY-MM-DDTHH:MM:SS) (UTC date time format)	Primary timestamp in Coordinated Universal Time
	DateTimeLocal	(YYYY-MM-DDTHH:MM:SS) (Local date time format)	Primary timestamp displayed in the timezone on the mobile device used to program the UPAS
Filter Sample	PumpingFlowRate	(L min ⁻¹)	The volumetric flow rate through the sample filter as calculated with our factory flow calibration curve shifted by the user-applied flow offset. If the log interval = 30 s, this is the time-average of the volumetric flow rate measured when the pumps were active. If the log interval = 1 s, this is the instantaneous volumetric flow rate (when the pumps were active) or zero (when the pumps were inactive).
	OverallFlowRate	(L min ⁻¹)	Duty cycle-adjusted flow rate through the sample filter as calculated with our factory flow calibration curve shifted by the user-applied flow offset; equal to PumpingFlowRate multiplied by the duty cycle.
	SampledVolume	(L)	Cumulative volume of air pulled through the sample filter as calculated with our factory flow calibration curve shifted by the user-applied flow offset.
	FilterDP	(Pa)	Differential pressure across the inlet and sample filter when pumps were active
Battery	BatteryCharge	(%)	Battery state of charge calculated as a percentage. Fully charge the UPAS battery before first-time use to ensure this value is accurate.
Atmo	AtmoT	(C)	Temperature measured by an RTD sensor in the air flow path. Representative of the atmospheric sampling conditions.
	AtmoP	(hPa)	Atmospheric pressure as measured on the surface of the UPAS PCB.
	AtmoRH	(%)	Relative humidity measured by a sensor in the air flow path (a value between 0 and 100).
	AtmoDensity	(g L ⁻¹)	Air density calculated from AtmoT, AtmoP, and AtmoRH
	AtmoAlt	(m)	Elevation in meters above sea level
GPS	GPSQual	(-)	NMEA GPS signal quality: 0 = no fix, 1 = autonomous GNSS fix, 2 = differential GNSS fix, 4 = RTK fixed, 5 = RTK float, 6 = estimated/dead reckoning fix (measured once per log interval). This column will be empty if the GPS was off.

	GPSlat	(decimalDegree)	Latitude; logged to six decimal places and accurate to a distance of approximately 0.15 m (measured once per log interval). This value will = -9999 if the GPS was on but a GPS signal was not available during the log interval. This column will be empty if the GPS was off.
	GPSlon	(decimalDegree)	Longitude; logged to six decimal places and accurate to a distance of approximately 0.15 m (measured once per log interval). This value will = -9999 if the GPS was on but a GPS signal was not available during the log interval. This column will be empty if the GPS was off.
	GPSalt	(m)	Altitude above sea level (measured once per log interval). This value will = -9999 if the GPS was on but a GPS signal was not available during the log interval. This column will be empty if the GPS was off.
	GPSsat	(integer)	Number of GPS satellite signals being received (measured once per log interval). This column will be empty if the GPS was off.
	GPSspeed	(m s ⁻¹)	Speed at which the GPS is moving (measured once per log interval). This value will = -9999 if the GPS was on but a GPS signal was not available during the log interval. This column will be empty if the GPS was off.
	GPSHDOP	(-)	Horizontal Dilution of Precision: represents the positional precision of the GPS relative to the accessible satellites (measured once per log interval). This value will = -9999 if the GPS was on but a GPS signal was not available during the log interval. This column will be empty if the GPS was off.
Motion	AccelX	(mg)	Linear acceleration in the X-direction, relative to the accelerometer position on the UPAS; used to estimate the orientation of the UPAS (if log interval = 30 s and duty cycle = 100%, this is an average of values measured at 1 Hz over the full 30-s; if log interval = 30 s and duty cycle < 100%, this is an average of values measured at 1 Hz while the pumps were off; if log interval = 1 s and duty cycle = 100%, this is an instantaneous measurement; if log interval = 1 s and duty cycle < 100%, this is an instantaneous value measured only when the pumps were off.)
	AccelXVar	(mg)	The variance in AccelX over the log interval (will be 0 or blank if log interval = 1 s)
	AccelXMin	(mg)	Minimum acceleration in the X-direction during the log interval
	AccelXMax	(mg)	Maximum acceleration in the X-direction during the log interval
	AccelY	(mg)	Linear acceleration in the Y-direction, relative to the accelerometer position on the UPAS (see the description of AccelX for additional details)
	AccelYVar	(mg)	The variance in AccelY over the log interval (will be 0 or blank if log interval = 1 s)
	AccelYMin	(mg)	Minimum acceleration in the Y-direction during the log interval
	AccelYMax	(mg)	Maximum acceleration in the Y-direction during the log interval
	AccelZ	(mg)	Linear acceleration in the Z-direction, relative to the accelerometer position on the UPAS (see the description of AccelX for additional details)

AccelZVar	(mg)	The variance in AccelZ over the log interval (will be 0 or blank if log interval = 1 s)
AccelZMin	(mg)	Minimum acceleration in the Z-direction during the log interval
AccelZMax	(mg)	Maximum acceleration in the Z-direction during the log interval
RotX	(mdeg s ⁻¹)	Estimate of rotational acceleration in the X-direction, relative to the accelerometer position on the UPAS; used to estimate movement of the UPAS (see the description of AccelX for additional details)
RotXVar	(mdeg s ⁻¹)	The variance in RotX over the log interval (will be 0 or blank if log interval = 1 s)
RotXMin	(mdeg s ⁻¹)	Minimum rotational acceleration in the X-direction during the log interval
RotXMax	(mdeg s ⁻¹)	Maximum rotational acceleration in the X-direction during the log interval
RotY	(mdeg s ⁻¹)	Estimate of rotational acceleration in the Y-direction, relative to the accelerometer position on the UPAS (see the description of AccelX for additional details)
RotYVar	(mdeg s ⁻¹)	The variance in RotY over the log interval (will be 0 or blank if log interval = 1 s)
RotYMin	(mdeg s ⁻¹)	Minimum rotational acceleration in the Y-direction during the log interval
RotYMax	(mdeg s ⁻¹)	Maximum rotational acceleration in the Y-direction during the log interval
RotZ	(mdeg s ⁻¹)	Estimate of rotational acceleration in the Z-direction, relative to the accelerometer position on the UPAS (see the description of AccelX for additional details)
RotZVar	(mdeg s ⁻¹)	The variance in RotY over the log interval (will be 0 or blank if log interval = 1 s)
RotZMin	(mdeg s ⁻¹)	Minimum rotational acceleration in the Z-direction during the log interval
RotZMax	(mdeg s ⁻¹)	Maximum rotational acceleration in the Z-direction during the log interval
AccelComplianceCnt	(#)	<p>Number of 30-s sample periods in the 10-min rolling average that detected UPAS motion. Min value of 0, max value of 20. Motion is detected if the AccelXVar, AccelYVar, or AccelZVar are > 100.</p> <p>This estimate will not be reliable when sampling at 100% duty cycle with a UPAS for which UPASexpRev is not "OBR2" because sample pump operation will make AccelComplianceCnt increment even if the UPAS is stationary; in such a situation, we recommend using StepCount to evaluate whether the UPAS was in motion. Refer to the device information in Table 9 to verify the value of UPASexpRev.</p>
AccelComplianceHrs	(hrs)	<p>Cumulative time that the compliance algorithm detected the UPAS in motion. This value increments by 30 s if AccelComplianceCnt > 0.</p> <p>This estimate will not be reliable when sampling at 100% duty cycle with a UPAS for which UPASexpRev is not "OBR2" because sample pump operation will make AccelComplianceCnt increment even if the</p>

			UPAS is stationary; in such a situation, we recommend using StepCount to evaluate whether the UPAS was in motion. Refer to the device information in Table 9 to verify the value of UPASexpRev.	
	Xup	(%)	Percent of time the UPAS was... ...in the Xup orientation during the log interval (see Figure 32)	
	XDown	(%)	... in the Xdown orientation during the log interval	
	Yup	(%)	... in the Yup orientation during the log interval	
	Ydown	(%)	... in the Ydown orientation during the log interval	
	Zup	(%)	... in the Zup orientation during the log interval	
	Zdown	(%)	...in the Zdown orientation during the log interval	
	StepCount	(#)	Estimated step count during the current log interval. This value might not be reliable when sampling with a duty cycle < 100% using a UPAS for which UPASexpRev is not "OBR2" because time-varying noise from the sampling pumps might cause inaccurate step count readings. If sample with a duty cycle < 100% using a UPAS for which UPASexpRev is not "OBR2," we recommend using the AccelComplianceCnt and AccelComplianceHrs variables to evaluate whether the UPAS was in motion. Refer to the device information in Table 9 to verify the value of UPASexpRev.	
	Light	LUX	(lux)	Measurement of illuminance from the Silicon Labs Si1133 light sensor. In the UPAS v2+, this sensor has a limited field of view and is installed behind a window; thus, we recommend interpreting all metrics reported by the light sensor as relative, and not exact, measurements.
		UVindex	(-)	Light sensor estimation of intensity of ultraviolet radiation from the sun (0 to 11+). Higher numbers represent higher exposures.
		HighVisRaw	(-)	Light sensor raw output for high-wavelength visible light. This metric (along with the LowVisRaw, IRRaw, and UVRaw metrics listed below) is included in the log file for experimental purposes only.
		LowVisRaw	(-)	Light sensor raw output for low-wavelength visible light
		IRRaw	(-)	Light sensor raw output for infrared (IR) light
		UVRaw	(-)	Light sensor raw output for ultraviolet (UV) light
PMSensor	PMMeasCnt	(#)	Number of PM measurements taken during this log interval; PM1MC, PM2_5MC, PM4MC, PM10MC, PM0_5NC, PM1NC, PM2_5NC, PM4NC, PM10NC, and PMtypicalParticleSize are averages of this many readings	
	PM1MC	($\mu\text{g m}^{-3}$)	PM _{1.0} mass concentration reported by the SPS30. We expect this value to be correlated with the "true" mass concentration, but do not recommend interpreting it as an exact concentration; scaling these sensor-reported values to a filter-derived PM _{1.0} concentration might improve accuracy, but no PM _{1.0} UPAS inlet is currently available.	
	PM1MCVar	($\mu\text{g m}^{-3}$)	The variance in PM1MC over log the interval	
	PM2_5MC	($\mu\text{g m}^{-3}$)	PM _{2.5} mass concentration reported by the SPS30. We expect this value to be correlated with the "true" mass concentration, but do not recommend interpreting this value as an exact concentration; scaling these sensor-reported values to a filter-derived PM _{2.5} concentration	

		might improve accuracy. For additional information, see: https://doi.org/10.1016/j.jaerosci.2020.105654
PM2_5MCVar	($\mu\text{g m}^{-3}$)	The variance in PM2_5MC over the log interval
PM4MC	($\mu\text{g m}^{-3}$)	PM _{4.0} mass concentration reported by the SPS30 sensor. Published data suggest that the SPS30 does not efficiently detect 4.0 μm particles; this value might not be correlated with the "true" PM _{4.0} mass concentration. For additional information, see: https://doi.org/10.5194/amt-13-2413-2020
PM4MCVar	($\mu\text{g m}^{-3}$)	The variance in PM4MC over the log interval
PM10MC	($\mu\text{g m}^{-3}$)	PM ₁₀ mass concentration reported by the SPS30 sensor. Published data suggest that the SPS30 does not efficiently detect 10 μm particles; this value might not be correlated with the "true" PM ₁₀ mass concentration. For additional information, see: https://doi.org/10.1021/acs.estlett.3c00030 https://doi.org/10.5194/amt-13-2413-2020
PM10MCVar	($\mu\text{g m}^{-3}$)	The variance in PM10MC over the log interval
PM0_5NC	(# cm^{-3})	Concentration of particles between 0.3 and 0.5 μm as reported by the SPS30
PM0_5NCVar	(# cm^{-3})	The variance in PM0_5NC over the log interval
PM1NC	(# cm^{-3})	Concentration of particles between 0.3 and 1.0 μm as reported by the SPS30
PM1NCVar	(# cm^{-3})	The variance in PM1NC over the log interval
PM2_5NC	(# cm^{-3})	Concentration of particles between 0.3 and 2.5 μm as reported by the SPS30
PM2_5NCVar	(# cm^{-3})	The variance in PM2_5NC over the log interval
PM4NC	(# cm^{-3})	Concentration of particles between 0.3 and 4.0 μm as reported by the SPS30
PM4NCVar	(# cm^{-3})	The variance in PM4NC over the log interval
PM10NC	(# cm^{-3})	Concentration of particles between 0.3 and 10.0 μm as reported by the SPS30
PM10NCVar	(# cm^{-3})	The variance in PM10NC over the log interval
PMtypicalParticleSize	(μm)	An indication of the average particle size as calculated and reported by the SPS30
PMtypicalParticleSizeVar	(μm)	The variance in PMtypicalParticleSize over the log interval
PMReadingErrorCnt	(#)	Number of reading errors during a logging period reported by the SPS30.
PMFanErrorCnt	(#)	Number of fan errors during a logging period reported by the SPS30.
PMLaserErrorCnt	(#)	Number of laser errors during a logging period reported by the SPS30.
PMFanSpeedWarn	(#)	Number of fan speed errors during a logging period reported by the SPS30.
PM2_5SampledMass	(μg)	Cumulative mass of PM _{2.5} sampled onto the filter as estimated from PM2_5MC and SampledVolume

EngData	PCB1T	(°C)	Temperature measured on the main UPAS PCB (1 of 2 locations)
	PCB2T	(°C)	Temperature measured on the main UPAS PCB (2 of 2 locations)
	FdpT	(°C)	Temperature measured at the differential pressure sensor downstream of the filter
	AccelT	(°C)	Temperature measured at the accelerometer
	PT100R	(Ω)	Resistance of the RTD (used to calculate AtmoT)
	PCB2P	(hPa)	Pressure measured on the UPAS PCB (2 of 2 locations)
	PumpPow1	(integer)	Main pump power level
	PumpPow2	(integer)	Secondary pump power level
	PumpV	(V)	Voltage input into the pumps
	MassFlow	(g min ⁻¹)	Air mass flow rate through the sample inlet and filter cartridge as calculated with our factory calibration curve shifted by the user-applied flow offset
	MFSVout	(V)	Voltage output by the internal mass flow sensor
	BFGenergy	(integer)	Battery fuel gauge output
	BattVolt	(V)	Battery voltage output
	v3_3	(V)	Main UPAS PCB 3.3V rail voltage
	v5	(V)	Main UPAS PCB 5V rail voltage
	PumpsON	(bool)	Pump operational state (0 = off, 1 = on)
	Dead	(bool)	Currently not used.
	BCS1	(bool)	Battery charging indicator; 1 = complete (magenta LED on UPAS while sampling)
	BCS2	(bool)	Battery charging indicator; 1 = in progress (blue LED on UPAS while sampling)
	BC_NPG	(bool)	0 = external power connected; 1 = no external power connected
	FLOWCTL	(s)	Time to read all sensors and write each line of data to the log file
	GPSRT	(s)	Time to read the GPS data
	SD_DATAW	(s)	Time to write each line of log data in the log on the SD card
SD_HEADW	(s)	Time to update the header data in the log file on the SD card	
TPumpsOFF	(s)	Amount of time the pumps were OFF during the log interval (for a 30-s log interval and a 50% duty cycle, this value should = 15 s)	
TPumpsON	(s)	Amount of time the pumps were ON during the log interval	
Gas	CO2	(ppm)	CO ₂ concentration measured by the Sensirion SCD41 CO ₂ sensor
	SCDT	(°C)	Temperature measured by the Sensirion SCD41 CO ₂ sensor
	SCDRH	(%)	Relative humidity measured by the Sensirion SCD41 CO ₂ sensor

VOCRaw	(-)	Raw VOC output signal from the Sensirion SGP41. This value should decrease as the VOC concentration increases; see Sensirion's datasheet for details. Access Sensor Technologies has not independently verified that this value is correlated with or accurately reflects the total VOC concentration.
NOxRaw	(-)	Raw NO _x output signal from the Sensirion SGP41. This value should increase as the NO _x concentration increases; see Sensirion's datasheet for details. Access Sensor Technologies has not independently verified that this value is correlated with or accurately reflects the NO _x concentration.

With gravity pulling down in the direction shown, this UPAS is in...

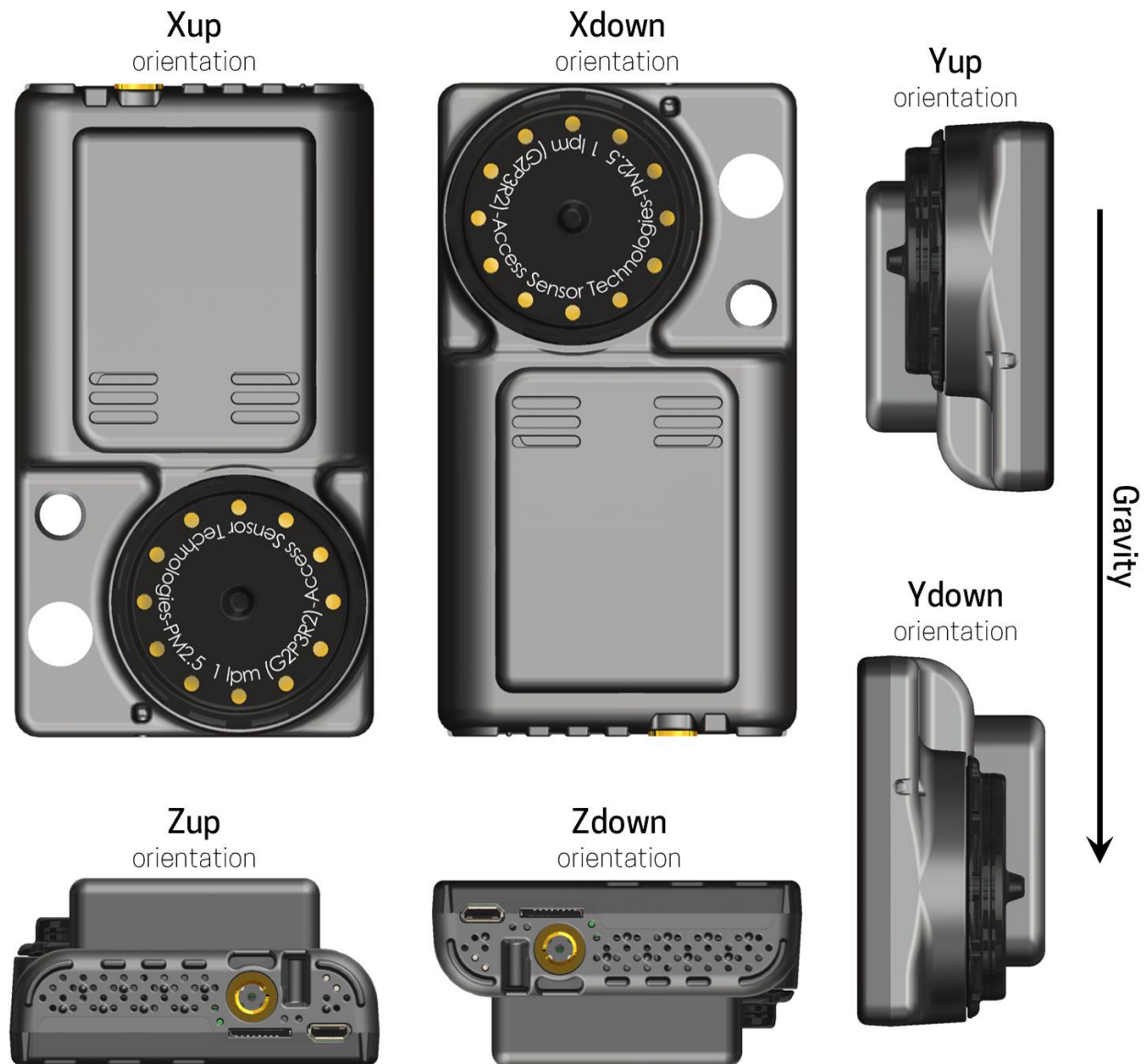

For example, if the UPAS is sitting on a table with the inlet facing "up" towards the sky.

Figure 32. Interpretation of the Xup, Xdown, Yup, Ydown, Zup, and Zdown variables in the sample log.

Web-based data visualization tool (R-Shiny application)

AST offers a web-based graphical user interface, in the form of an R-Shiny application, for summarizing and plotting data from UPAS log files. You can access the Shiny application at: <https://accsensortech.shinyapps.io/shinyAST/>

To load a UPAS log file into the Shiny application, click the “Upload” button, navigate to the file(s) you want to upload, and click “Open.” You can upload multiple files at once. Files uploaded to the Shiny application are not shared with Access Sensor Technologies or any other third party.

The Shiny application has four tabs: Sample Summary, Plots, GPS Map, and Report Generation (**Figure 33**). The functionality of the first three tabs is described below; the Report Generation tab is still under development.

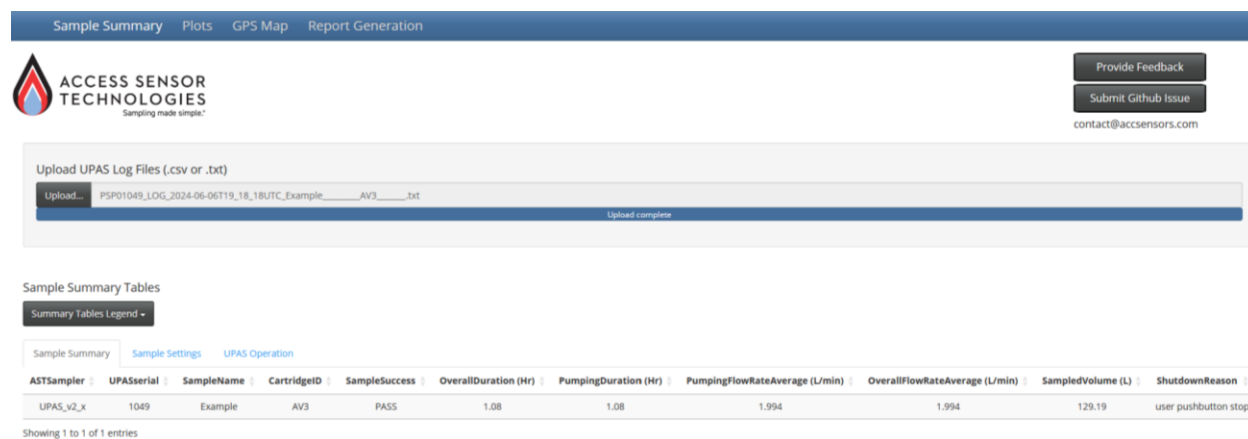

The screenshot shows the Shiny application interface. At the top, there are navigation tabs: Sample Summary, Plots, GPS Map, and Report Generation. Below the tabs is the Access Sensor Technologies logo and contact information. The main area is titled "Upload UPAS Log Files (.csv or .txt)" and contains an upload button and a file input field. Below this is a "Sample Summary Tables" section with a "Summary Tables Legend" dropdown. The "Sample Summary" tab is selected, showing a table with the following data:

ASTSampler	UPASserial	SampleName	CartridgeID	SampleSuccess	OverallDuration (Hr)	PumpingDuration (Hr)	PumpingFlowRateAverage (L/min)	OverallFlowRateAverage (L/min)	SampledVolume (L)	ShutdownReason
UPAS_v2_x	1049	Example	AV3	PASS	1.08	1.08	1.994	1.994	129.19	user pushbutton stop

Showing 1 to 1 of 1 entries

Figure 33. The Sample Summary table in the Shiny application.

Sample Summary

Once a log file is uploaded to the Shiny application, a summary of the sample will appear in the Sample Summary table (**Figure 33**). The Sample Summary table displays select data from the log file header that are useful for confirming that the sample(s) ran successfully. Look through these values to confirm that the sample ran for the desired duration, at the desired flow rate, and that the UPAS did not shut down in error:

- **ASTSampler:** Model of the device used to collect the sample.
- **UPASserial:** UPAS serial number.
- **SampleName:** Sample name entered by the user into the mobile application.
- **CartridgeID:** Filter cartridge identifier entered by the user into the mobile application.
- **SampleSuccess:** This column will display PASS if the ShutdownMode was 1 (user pushbutton sample stop) or 3 (successfully completed preset sample duration). This column will display FAIL, and the row will be shaded red, if the ShutdownMode was anything else (see **Table 9**).
- **OverallDuration (Hr):** Overall sample log duration.
- **PumpingDuration (Hr):** Overall duration for which the pumps pulled air through the sample filter.
- **PumpingFlowAvgFactory (L/min):** Sample-averaged flow rate through the filter when the pumps were on as calculated using our factory calibration curve.
- **OverallFlowAvgFactory (L/min):** Sample-averaged flow rate through the filter as calculated

using our factory calibration curve (will be equal to PumpingFlowAvgFactory if the FlowDutyCycle was 100%).

- **SampledVolumeFactory (L):** Volume of air sampled through the filter as calculated using our factory calibration curve.
- **PumpingFlowAvgOffset (L/min):** Sample-averaged flow rate through the filter when the pumps were on as calculated with the calibration curve shifted by the user-applied flow offset.
- **OverallFlowAvgOffset (L/min):** Sample-averaged flow rate through the filter as calculated with the calibration curve shifted by the user-applied flow offset (will be equal to PumpingFlowAvgOffset if the FlowDutyCycle was 100%).
- **SampledVolumeOffset(L):** Volume of air sampled through the filter as calculated with the calibration curve shifted by the user-applied flow offset.
- **ShutdownReason:** Text describing the meaning of the numeric ShutdownMode value; see the ShutdownMode row in **Table 9**).

The Sample Settings table displays select data from the log file header that are useful for confirming that the sample settings were programmed correctly using the mobile application:

- **StartOnNextPowerUp:** Was the UPAS programmed to start on next power-up? (0 = no, 1 = yes, 4 = always start on next power-up).
- **ProgrammedStartTime (sec since 1/1/1970):** The time when the sample was programmed to start; 0 = "now" or "start on next power up"; otherwise equal to seconds since 1/1/1970.
- **ProgrammedRuntime (Hr):** Programmed sample run time.
- **SizeSelectiveInlet:** PM size fraction collected by the size-selective inlet installed on the UPAS. This value indicates the size-selective inlet that the user specified in the mobile application.
- **FlowRateSetpoint (L/min):** Programmed volumetric flow rate.
- **FlowDutyCycle (%):** Pump duty cycle (possible values range from 13% to 100%).
- **GPSEnabled:** Will display TRUE or FALSE depending on whether the GPS module was enabled.
- **PMSensorOperation:** Text describing the operational state of the time-resolve PM sensor (see the PMSensorInterval row in **Table 9** for additional information).
- **RTGasSampleState:** Will display TRUE or FALSE depending on whether the Sensirion SGP41 VOC/NO_x sensor was enabled.
- **LogInterval (s):** Interval at which data were written to the log file.
- **PowerSaveMode:** Will display TRUE or FALSE depending on whether the UPAS was used in power-save mode. In power-save mode, the GPS is turned off and PMSensorInterval = 15 (30-s warm-up, followed by 30-s measurement, followed by 14-minute sleep period) between 9 PM and 4 AM local time.
- **AppVersion:** The version of the mobile application that was used to program the UPAS.

The UPAS Operation table displays data from the log file header that are useful for confirming if (a) the sample started and ended at the correct times and (b) the UPAS battery died during the sample.

- **StartDateTimeUTC:** Timestamp when the sample started (coordinated universal time).
- **EndDateTimeUTC:** Timestamp when the sample ended (coordinated universal time).
- **StartBatteryVoltage (V):** Battery voltage when the sample started.
- **EndBatteryVoltage (V):** Battery voltage when the sample ended. The UPAS will shut down if the battery voltage drops below 2.8 V.
- **StartBatteryCharge (%):** Battery state of charge when the sample started.

- **EndBatteryCharge (%):** Battery state of charge when the sample ended.
- **GPSUTCOffset (Hr):** The number of hours by which time in the local time zone where the sample was collected differs from coordinated universal time.
- **FirmwareRev:** The version number of the firmware running on the UPAS.
- **ShutdownMode:** A numeric code indicating the reason why the UPAS shut down. See **Table 9** for a description of each code.

Plots

Here, you can plot any variable from the sample log against any other variable from the sample log (see example in **Figure 34**). To generate a plot using the Plot Settings box:

- Use the X Variable drop-down menu to select the variable that you want on the x-axis.
- Use the Y Variable drop-down menu to select the variable that you want on the y-axis.
- If you need help recalling the significance of each variable in the Sample Log, click “Variable Legend” and then click “UPAS v2+” or “UPAS v2” to bring up a .pdf file containing the Log File Legend for the corresponding device.
- In the Line Type drop-down menu, select “point” if you want each timestamp in the log file to appear as a distinct data point; select “line” if you want the log data to appear as a continuous line that connects the data points recorded at each timestamp.
- Use the Unit Format drop-down menu to indicate how you want the units that appear on the x- and y-axis labels to be formatted.
- Click the “Generate Plot” button to generate the plot.

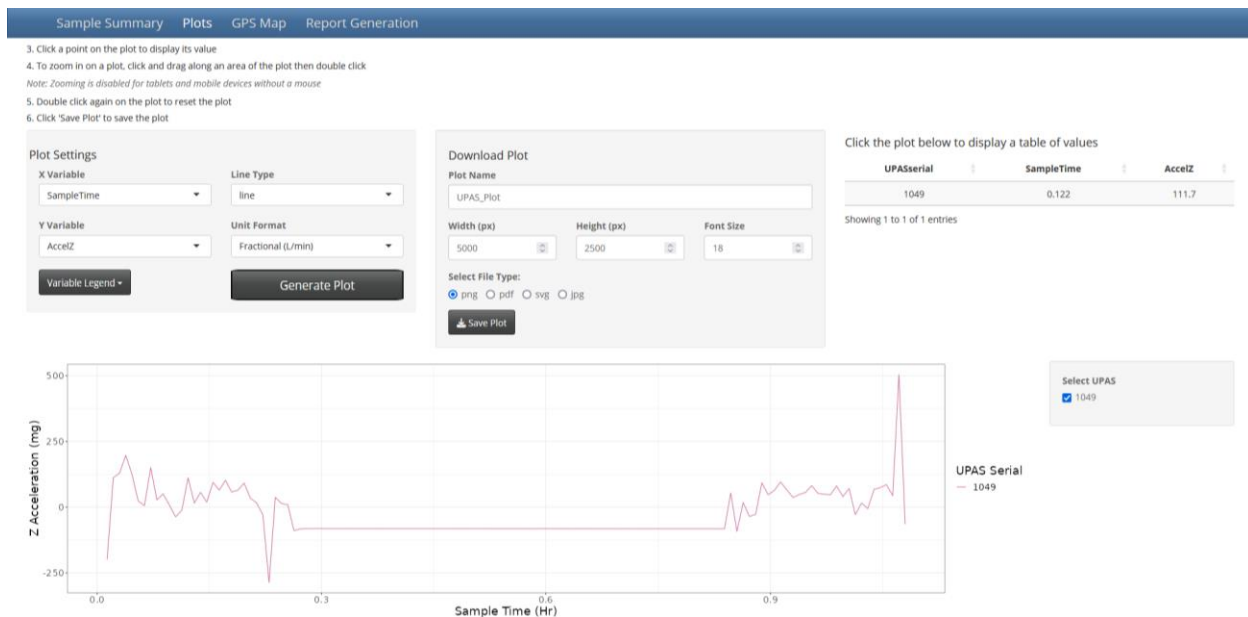

Figure 34. A line plot of UPAS acceleration as a function of the time into the sample in hours. A data point has been selected for display in the table in the upper-right corner of the window.

Tips for using the Plots tab:

- If you have log files from multiple UPAS uploaded to the Shiny application, you can check or uncheck the boxes to the right of the plot to show or hide the data from each UPAS serial ID.
- To zoom in on a specific area of the plot, hover your cursor over the plot until the pointer turns

into a cross. Click and drag to draw a box around the area you want to zoom in on; then, double-click to zoom in on the selected area.

- To zoom back out to the full plot after zooming in on a specific area, double-click anywhere on the plot background.
- If you click on a specific data point, the UPAS serial ID, x-value, and y-value associated with that data point will be displayed in a table to the right of the Download Plot box.

You can download the plot displayed here using the Download Plot box:

- Under Plot Name, enter the filename under which you want to save the plot.
- Enter the width and height of the plot in pixels.
- Enter the font size for the axis labels in points.
- Select the file type that you want to save the plot as (.png, .pdf, .svg, or .jpg).

Click “Save Plot” to download the image.

GPS Map

On the GPS Map tab, the time-resolved $PM_{2.5}$ concentrations recorded by the Sensirion SPS30 sensor inside the UPAS v2.1 PLUS (i.e., the $PM_{2.5}MC$ variable from the Sample Log; see **Table 11**) will be displayed on a map. Each data point on the map will be color-coded according to the $PM_{2.5}$ concentration reported by the SPS30 sensor (see example in **Figure 35**).

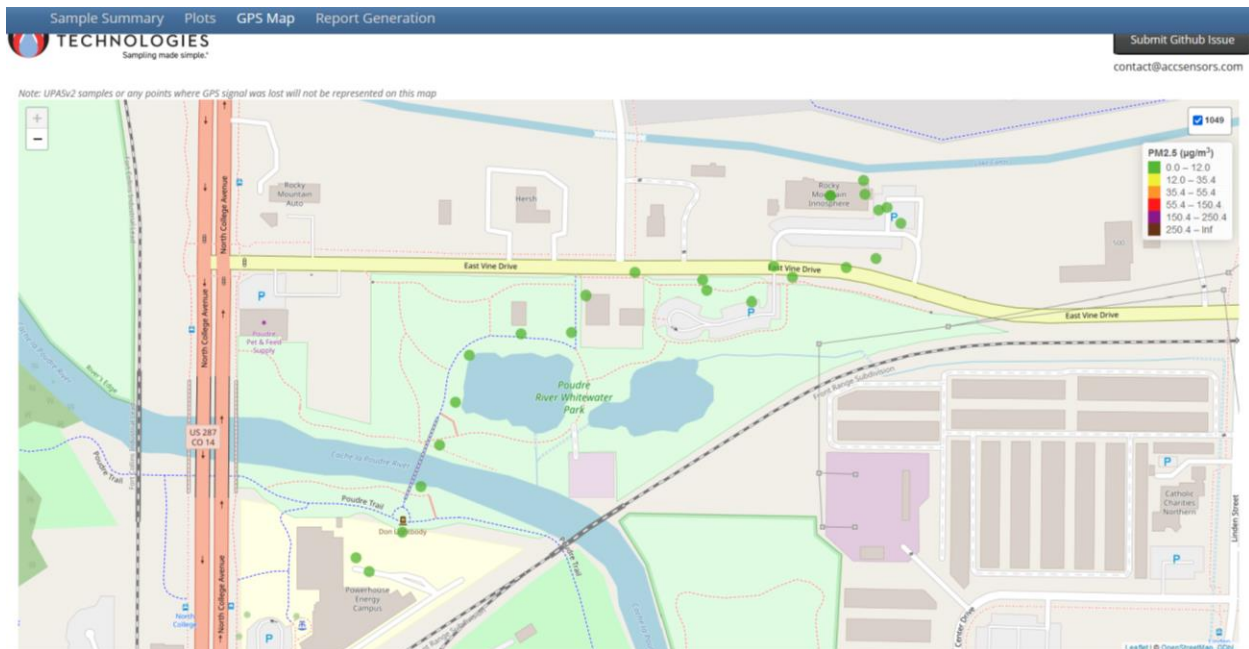

Figure 35. An example map of Sensirion SPS30 sensor-reported $PM_{2.5}$ concentrations ($PM_{2.5}MC$) as a function of the GPS location (GPSlat, GPSlong) recorded in a UPAS v2.1 PLUS sample log.

Tips for using the GPS Map tab:

- If you have log files from multiple UPAS uploaded to the Shiny app, you can check/uncheck the boxes in the upper-right corner of the map to show or hide the data from each UPAS serial ID.
- To move around the map, hover your cursor over the map until the pointer turns into a hand. Click and drag to change the area displayed.

- To zoom in and out, use the + and - buttons in the upper-left corner of the map. You can also hover over the map and then use the zoom functionality on your trackpad or mouse.
- If you click on an individual data point, a pop-up box will display the PM_{2.5} concentration reported by the SPS30 sensor, the UPAS serial ID, and the local timestamp when that point was recorded. Click the “x” in the top-right corner of the pop-up box to close it.

No map or data will appear on the GPS Map tab if:

- The log file was collected using a UPAS v2, which does not contain a time-resolved PM sensor;
- No GPS data were recorded because the GPS module was off during the sample; or
- No GPS data were recorded because the device was unable to receive a GPS signal during the sample.

Providing Feedback

If you want to report an issue, request a feature, or provide any other feedback on this R-Shiny application, you can do so by:

- 1 Clicking the “Provide Feedback” button in the upper-right corner of the application window to provide feedback using a Microsoft Office form or
- 2 Emailing contact@accsensors.com.

Note that the “Submit Github Issue” button will only work for developers who have access to the GitHub repository associated with the R-Shiny application.

R Package

AST offers a package for reading UPAS log file data into R.

The `astr` package can be installed from our GitHub: <https://github.com/accsensors/astr>

Refer to the README and the function documentation, especially for the `read_ast_header` and `read_ast_log` functions, for information on how to use the package.

Analyzing filter sample data

The most common use of the UPAS is to measure a time-averaged mass concentration of particulate matter (PM) pollution in air by sampling the air through a size-selective inlet followed by a sample filter. The size-selective inlet is designed to only let particles in a specific size range (e.g., particles with aerodynamic diameters $\leq 2.5 \mu\text{m}$) reach the sample filter. All particles that make it through the inlet are then collected on the filter. The sample filter often undergoes gravimetric analysis to determine the mass of PM collected on the filter during the sample. In other words, the filter gets weighed before and after the sample, typically to the nearest $1 \mu\text{g}$. Then, the time-averaged concentration of PM that was present in the air during the sample (\overline{PM}_{filter} in micrograms of PM per cubic meter of air; $\mu\text{g m}^{-3}$) can be calculated using Equation 3:

$$\overline{PM}_{filter} = \frac{\Delta m_{filter} - \Delta m_{blank}}{V_{air}} \quad \text{Eq. (3)}$$

Δm_{filter} is the change in the mass of the sample filter between pre- and post-sample weighing (μg). This value will be given to you by the laboratory that analyzed your filter sample.

$\overline{\Delta m_{blank}}$ is the mean change in mass of the field blank filter samples collected during the measurement campaign (μg). If you do not know the value of $\overline{\Delta m_{blank}}$ (for example, because your campaign is not yet over and not all of the blank samples associated with it have been analyzed) or if the value of $\overline{\Delta m_{blank}}$ differs from zero by a negligible amount, you might set $\overline{\Delta m_{blank}} = 0$.

V_{air} is the volume of air sampled through the filter (m^3). Get V_{air} from the “SampledVolume” parameter in the Sample Summary section of the *log file header*. Note that SampledVolume is given in liters in the log file header. Divide the SampledVolume in liters by 1000 to convert to cubic meters.

Interpreting time-resolved particulate matter sensor data

The $\text{PM}_{2.5}$ concentration reported by a low-cost optical PM sensor, like the Sensirion SPS30 included in the UPAS v2.1 PLUS, is typically correlated with the “true” $\text{PM}_{2.5}$ concentration, but is often an under- or overestimate of the true $\text{PM}_{2.5}$ concentration due to differences between the size distribution, refractive index, and shape of the real-world PM being measured versus the size distribution, refractive index, and shape of the PM used to calibrate the sensor. To improve the accuracy of the time-resolved $\text{PM}_{2.5}$ estimates, we recommend scaling the $\text{PM}_{2.5}$ concentrations reported by the SPS30 sensor during each sample (“PM2_5MC” in the sample log) by the ratio of the sample-averaged $\text{PM}_{2.5}$ concentration derived from gravimetric analysis of a concurrent filter sample to the sample-averaged $\text{PM}_{2.5}$ concentration reported by the sensor. Using this approach, the “corrected” $\text{PM}_{2.5}$ concentration is calculated as:

$$PM_{2.5,corrected} = PM_{2.5,SPS30} \left(\overline{PM_{2.5,filter}} / \overline{PM_{2.5,SPS30}} \right) \quad \text{Eq. (4)}$$

where $PM_{2.5,corrected}$ is the corrected 30-s average $\text{PM}_{2.5}$ concentration, $PM_{2.5,SPS30}$ is the 30-s average $\text{PM}_{2.5}$ concentration reported by the SPS30 sensor (“PM2_5MC” in the sample log), $\overline{PM_{2.5,filter}}$ is the sample-averaged $\text{PM}_{2.5}$ concentration derived from gravimetric analysis of the filter sample, and $\overline{PM_{2.5,SPS30}}$ is the time-averaged $\text{PM}_{2.5}$ concentration reported by the SPS30 over the duration of the filter sample (all in $\mu\text{g m}^{-3}$).

Several peer-reviewed studies have shown that low-cost optical PM sensors, like the SPS30 sensor included in the UPAS v2.1 PLUS, do a poor job detecting PM_4 and PM_{10} . It is unlikely that the $\text{PM}_{4.0}$ and PM_{10} concentrations reported by the SPS30 (“PM4MC” and “PM10MC”, respectively, in the sample log) are correlated with the true PM_4 and PM_{10} concentrations, respectively, and we do *not* recommend using these data.

For additional information, we recommend the following references:

- Li et al., 2024, DOI: [10.1080/02786826.2024.2415481](https://doi.org/10.1080/02786826.2024.2415481)
- Ouimette et al., 2023, DOI: [10.1080/02786826.2023.2285935](https://doi.org/10.1080/02786826.2023.2285935)
- Molina Rueda et al., 2023, DOI: [10.1021/acs.estlett.3c00030](https://doi.org/10.1021/acs.estlett.3c00030)
- Tryner et al., 2020, DOI: [10.1016/j.jaerosci.2020.105654](https://doi.org/10.1016/j.jaerosci.2020.105654)
- Kuula et al., 2020, DOI: [10.5194/amt-13-2413-2020](https://doi.org/10.5194/amt-13-2413-2020)

Shutdown modes

The “Sample Summary” header section of each UPAS log file contains a shutdown mode number that indicates the reason the UPAS shut down. Use **Table 12** to interpret the shutdown mode number.

Further troubleshooting may be warranted for some shutdown modes. When possible, follow the recommendations outlined below to identify the possible cause(s) for each mode and perform basic troubleshooting. If a problematic shutdown mode persists, contact AST for assistance.

Table 12. Meaning of shutdown mode number listed in UPAS log file header and recommended action.

Shutdown mode	Meaning	LED color before shutdown	Recommended action
0	Unknown error shutdown	Not applicable	Contact AST for support.
1	User pushbutton sample stop	LED turned off after 5 second pushbutton hold during sample	No action is needed; the sample was manually stopped.
2	Depleted battery shutdown [$<2.8V$]	Red LED flashing	Re-charge the UPAS battery.
3	Successfully completed preset sample duration	Green LED on, then off when sample completed	No action is needed; the UPAS is ready for another sample.
4	Thermal protection shutdown	Green LED on then off	Troubleshoot as outlined below.
5	Maximum power at initialization error	Red LED on	Troubleshoot as outlined below.
6 or 7	Maximum pump voltage or blocked flow during sample shutdown	Red LED on	Troubleshoot as outlined below.
8	SD card removed during sample	Green LED on then off	Reinstall microSD card.
64-79	UPAS freeze	Green LED on then off	Contact AST for support.
80+	UPAS crash (RTOS)	Green LED on then off	Contact AST for support.

Shutdown Mode 0 or 60+: Unknown error, UPAS freeze, or UPAS crash

These are unexpected and rare errors. Contact AST at support@accsensors.com for further assistance. If possible, attach the log file(s) with Shutdown Mode = 0 or 60+ to your email.

Shutdown Mode 4: Thermal protection

This shutdown mode is triggered when the UPAS atmospheric temperature sensor reading (“AtmoT” in the sample log) exceeds 60°C (140°F). An example thermal protection shutdown event, as plotted using our web-based data visualization tool, is shown in **Figure 36**. Observing the time and location, when available, of the high-temperature event detected by the UPAS may help you determine whether there was a plausible external cause.

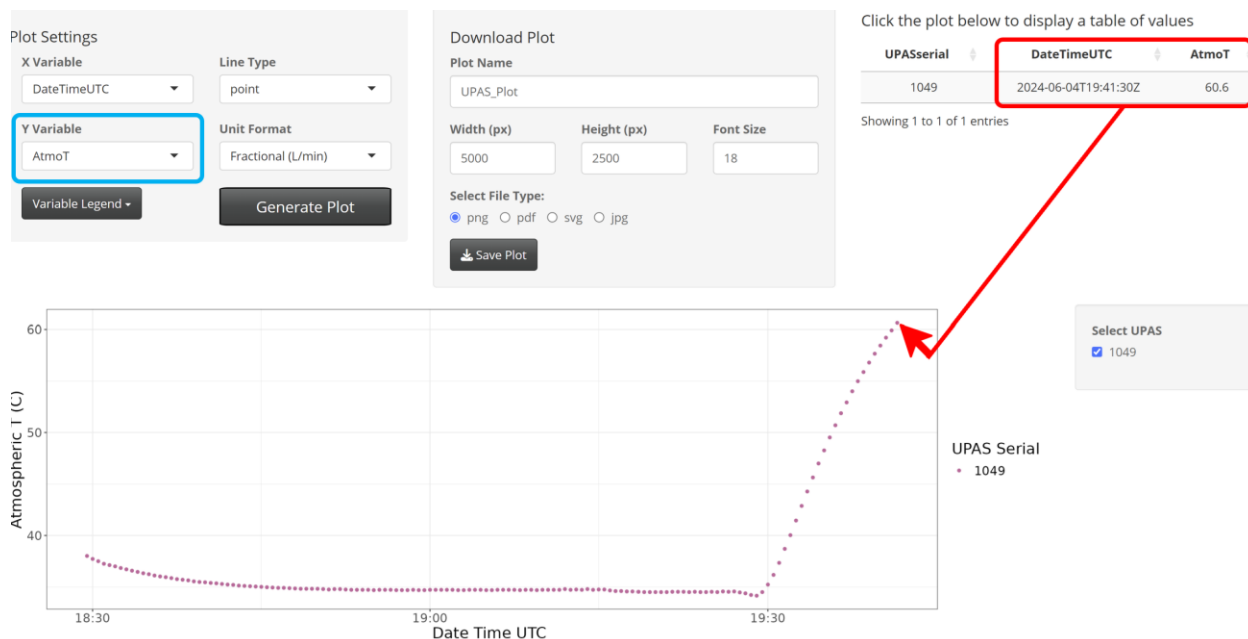

Figure 36. Example plot of “AtmoT” (blue box) during a sample in which the UPAS recorded a temperature exceeding 60 °C (red box) and shutdown mode 4 (thermal protection) was triggered.

If you cannot identify a plausible cause for the high-temperature event, run a short test sample with similar settings in a room temperature environment where a thermal shutdown is not expected. Open the resultant sample log file:

- If the shutdown mode = 3 in the new file, this result could indicate that the UPAS detected a real high-temperature event during the sample with shutdown mode = 4 and the shut down as intended to protect the device.
- If the shutdown mode = 4 in the new file, the UPAS might not be working as expected. Contact AST at support@accsensors.com for assistance. If possible, attach the log file(s) with shutdown mode = 4 to your email.

Shutdown Mode 5: Maximum power at initialization

This shutdown mode is triggered when the pump voltage exceeds the maximum value (29 V) while the UPAS is attempting to reach the target flow rate at the start of the sample. First, verify that the UPAS inlet and filter cartridge are clean and have no blockages. Refer to the Size-Selective Inlet User Guide for cleaning instructions. Install a clean inlet and a clean filter cartridge with a new filter in the UPAS. Then, run a 5-minute test sample with similar settings. Open the resultant log file:

- If shutdown mode = 3 in the new file, the original shutdown mode = 5 was likely caused by a clogged inlet and/or an overloaded filter.

- If the shutdown mode = 5 in the new file, the original shutdown mode = 5 was not caused by a clogged inlet a clogged inlet and/or an overloaded filter.

Second, verify that the UPAS can control the filter sample flow rate to the target value with the selected filter media. To test the ability of the UPAS to sample air through the selected filter media, run a 5-minute sample with similar settings in a relatively clean environment without a filter installed. Open the resultant log file:

- If the shutdown mode = 3 in the new file, the filter media is likely the cause of the shutdown. The pressure drop across the clean filter is too high and the UPAS cannot achieve the target volumetric flow rate through the filter. Consider whether a different filter type with a lower resistance to flow can be used in your sampling application (e.g., a filter with a larger pore size or a 37-mm-diameter filter instead of a 25-mm-diameter filter). See **Table 4** for information on filters that have been tested with the UPAS.
- If the shutdown mode = 5 in the new file, the filter media is not the cause of the shutdown.
- If shutdown mode 5 persists, refer to **Section 6** of this guide to conduct a DIAGNOSTIC test.

Shutdown Mode 6 or 7: Maximum pump voltage or blocked flow during sample

Shutdown Mode 6 is triggered if the pump voltage exceeds the maximum value (29.75 V) while attempting to maintain the target filter sample volumetric flow rate during the sample. Shutdown Mode 7 is triggered if the main pump power level (PumpPow1 in the sample log) is set to 14 for more than 60 seconds. If shutdown mode 6 or 7 is triggered, you can assume that the UPAS was able to reach the target flow rate at the start of the sample.

Verify that no obstruction was introduced during the sample that might have reduced the flow through the UPAS inlet (for example, a non-breathable fabric covering the inlet of the UPAS). If the inlet is obstructed, the pump voltage will increase to try to maintain the target flow rate and the UPAS will shut down, as expected, if the pump voltage exceeds 29.75 V or the main pump power level (PumpPow1) is set to 14 for more than 60 seconds during this process.

If it seems unlikely that the UPAS inlet became obstructed during the sample, place the UPAS inlet-up on a table, where no obstruction is present, and run a 5-minute test sample with similar settings. Open the resultant log file:

- If the shutdown mode = 3 in the new file, this result could indicate that the UPAS detected a real flow-blockage during the sample with shutdown mode = 6 or 7 and the shut down as intended to protect the device.
- If the shutdown mode = 6 or 7 in the new file, the UPAS might not be working as expected. Contact AST at support@accsensors.com for assistance. If possible, attach the log file(s) with shutdown mode = 6 or 7 to your email.

Shutdown Mode 8: SD card removed during sample

This shutdown mode is triggered if the microSD card is removed for more than 5 minutes during the sample. If the microSD is re-installed before the 5-minute timeout, the log file will resume writing to the microSD; in this case, sample log lines that tried to write while the microSD card was removed will be omitted from the log file.

6 Device Maintenance

Internal lithium-ion battery

The UPAS contains a 24Wh lithium-ion (Li-ion) battery, which is not accessible to the user. The UPAS and battery have built-in protection to prevent overcharge, over-discharge, over-drain, and short circuits. Refer to Section 3 for charging instructions. The voltage of the internal battery can be determined by connecting to the UPAS with the mobile app and then looking at the value displayed on the “Battery Voltage” line (**Figure 21**). The battery voltage is also recorded in the log file at the start of the sample, the end of the sample, and each interval in the sample log (**Table 9** and **Table 11**).

Before shipping a UPAS via ground or air transportation, run or charge the UPAS until the battery voltage is between 3.0 and 3.4 V. For shipping purposes, the UPAS and internal battery are categorized under UN3481, PI967: Lithium-ion batteries contained in equipment.

If the UPAS will go unused for a period of 1 week or longer, we recommend storing it at 10 to 25 °C, in an environment with low humidity, and with the battery at 3.6 to 3.8 V. Because storing the UPAS battery at or near full charge (4.2 V and 100% SOC) can lead to reduced battery energy capacity and shorter maximum sample runtimes, we recommend bringing the battery voltage to 3.8 V before putting the UPAS into storage. While the UPAS is in storage, we recommend checking the battery voltage every 2 months and, if the voltage has dropped below 3.6 V, recharging it to 3.8 V.

Follow one of the procedures below to bring the battery to a specific voltage for shipping or storage.

When starting with a fully-charged battery: Connect to the UPAS with the mobile app and note the starting battery voltage (V_{start} ; expected to be 4.2 V if the UPAS is fully-charged). Then, install a filter in the UPAS and run a 1-h sample. Check and note the battery voltage at the end of the hour (V_{end}). Use Equation 5 to calculate the time, t , in hours that the UPAS must run with your sample settings to deplete the battery to the target voltage (V_{target} = 3.4 V for shipping or 3.8 V for storage). Then, run a t -hour sample and check the battery voltage again. Repeat this process as needed until the battery voltage reaches the target value.

$$t = \frac{V_{end} - V_{target}}{V_{start} - V_{end}} \quad \text{Eq. (5)}$$

When starting with a fully-depleted battery (2.8 V): Charge the UPAS for 30 minutes. Then, connect to the UPAS with the mobile app and check the battery voltage. Repeat this procedure until the battery voltage reaches the target value (3.0 V to 3.4 V for shipping or 3.8 V for storage).

Diagnostic test

The diagnostic (DIAG#) test automatically cycles the UPAS through a comprehensive series of tests. The data from the resultant log file, combined with flow rate measurements from a reference meter (optional), can provide insight into the operational health of the UPAS.

- Only use the diagnostic test to evaluate the operational health of the UPAS. Do not use the diagnostic test mode to collect a real sample.
- There are two ways to conduct the diagnostic test depending on the availability of a primary flow meter. We recommended performing the test with a primary flow rate meter connected to the UPAS inlet; however, an *alternate method is provided if a UPAS-compatible primary flow rate meter is not available*. Refer to **Section 3** for information on UPAS-compatible primary flow rate meters.
- The diagnostic test takes approximately 10 minutes per UPAS to complete.

The diagnostic test procedure is as follows:

- 1 Configure the UPAS as shown in **Figure 16** to check the sample flow rate against a primary flow rate meter. Install a similar filter, filter cartridge, and size-selective inlet as intended for the real sample.
If not using a flow meter, set aside a similar filter, filter cartridge, and size-selective inlet as intended for the real sample. These components will be installed after the first pumping step of the test.
- 2 Record the type of filter and size-selective inlet used for the test. Air will be sampled during the filter during the test.
- 3 Power the UPAS on and wait for the power-on sequence to complete (**Table 5**) and for the LED to turn solid **pink**.
- 4 Connect to the UPAS with the app (**Section 4**).
- 5 If testing a UPAS v2.1 PLUS, configure the PM and gas sensor settings as intended for the real sample.
- 6 Set the “Start Time” to “Now”,
- 7 In the “Sample Name”, enter “DIAG#”. This command will overwrite some other sample settings temporarily when the diagnostic test is started.
- 8 If using an Alicat flow meter, set the pressure unit to kPaG (top left unit on screen), and set the flow rate unit to LPM (bottom left unit on screen). With your finger, block the outlet of the flow meter.
*If not using a flow meter, block the hole in the center of the UPAS inlet socket (see **Figure 2**) with your finger.*
- 9 “Start” the diagnostic sample from the app.
- 10 First, the UPAS pumps will be set to maximum power for 3 s. With the flow blocked, if using an Alicat flow rate meter, record the maximum gauge pressure (kPaG) displayed on the screen.

If not using a flow meter, record nothing.

11 When you hear the pumps turn off after 3 seconds, unblock the flow meter outlet.

*If not using a flow meter, remove your finger from the inlet socket and install the filter, filter cartridge and size-selective inlet as shown in **Figure 11** through **Figure 13**.*

12 Second, the UPAS pumps will be set to maximum power for another 3 seconds. With flow unblocked, record the maximum volumetric flow rate (L min⁻¹) displayed on the meter.

If not using a flow meter, make sure the flow into the UPAS is unblocked, but record nothing.

13 Third, the UPAS pumps will be set to minimum power for 3 seconds. Ensure that airflow through the meter and UPAS remains unblocked, but no further action is needed at this step.

14 Next the UPAS will target a 1.0 L min⁻¹ sample flow rate. Allow the UPAS to run for 3 minutes. If the UPAS LED is green, record the volumetric flow rate displayed on the meter.

If not using a flow meter, wait for 3 minutes and record nothing.

15 Press the UPAS pushbutton two times, pausing for 1-second in between each press.

16 The UPAS will now target a 2.0 L min⁻¹ sample flow rate. Allow the UPAS to run for 3 minutes. If the UPAS LED is green, record the volumetric flow rate displayed on the meter.

If not using a flow meter, wait for 3 minutes and record nothing.

17 Power the UPAS off by holding the pushbutton down for 5 seconds.

18 Download the diagnostic log file from the UPAS microSD card (**Section 5**) to a computer.

19 Email the following information to support@accsensors.com for further assistance.

- Relevant background information to the UPAS malfunction or condition.
- The filter media type, filter size, and size-selective inlet used during the diagnostic test.
- The diagnostic log file from the UPAS microSD card.
- All information recorded during the diagnostic test if a flow meter was used (Table 13).

Table 13. Data to record during a diagnostic test if a primary flow rate meter is connected to the UPAS inlet.

Step	Pump setting	Inlet condition	Metric	Value	Units
10	Maximum power	Blocked	Gauge pressure		kPaG
12	Maximum power	Unblocked	Sample flow rate		L min ⁻¹
14	1.0 L min ⁻¹ target flow rate	Unblocked	Sample flow rate		L min ⁻¹
16	2.0 L min ⁻¹ target flow rate	Unblocked	Sample flow rate		L min ⁻¹

Installing and updating UPAS firmware

New UPAS are shipped with the most recent firmware version installed. If you need to install new firmware on your UPAS, follow the instructions below.

Determine the firmware version installed on the UPAS

Use one of the following two methods to determine the firmware version installed on the UPAS:

- Connect the UPAS to the app (see **Section 4**). The firmware revision will be displayed in the “Firmware Revision” field in the Main Menu (see **Figure 21**).
- Open a recent log file from the UPAS. The firmware revision will be listed in the first section of the log file header. Find the parameter called “UPASfirmware” and then look at the number that follows “rev_” in the value associated with that parameter.

Prepare for firmware installation

- Download the firmware .bin file to your computer. The Rev157 firmware file name is:
[UPAS_v2_x.NUCLEO_L476RG_RELEASE_20230830_rev157.bin](#)
- Connect the UPAS to a computer using a USB-A to micro-USB or USB-C to micro-USB cable.
Tip: If you have difficulty with any of the following steps, try connecting the UPAS to a different USB port on your computer or try using a different USB-A or USB-C to micro-USB adapter/cable, preferably from a reputable brand (e.g., Anker).
- Power ON the UPAS by pressing and holding the pushbutton until the computer recognizes the device “DAPLINK(D).” Then, release the pushbutton.

Install the firmware

Using a Microsoft computer or an Apple computer running MacOS v12 or earlier:

- 1 Drag and drop or copy and paste the firmware file onto the “DAPLINK(D)” device. Approve any permissions and wait for the process to complete (~30 seconds).
- 2 The UPAS will disconnect from the computer for a moment and automatically restart.

Using an Apple computer running MacOS v13 or later:

- 1 Open the mac program called “Terminal”.
- 2 Use a text editor to modify this code to include the location of the new firmware binary file:

```
rsync /Users/ast/Downloads/UPAS_v2_x.NUCLEO_L476RG_RELEASE_20230830_rev157.bin /Volumes/DAPLINK
```

- 3 Copy and paste your code into terminal, and press “return”.
- 4 Wait for the DAPLINK folder to disappear and then reappear.

Verify that the new firmware was installed successfully

Disconnect the UPAS from the computer and use one of the methods above to verify that the firmware installed on the UPAS is the new version.

7 Frequently Asked Questions

The LED is blinking pink and I can't connect to the app. What should I do?

The UPAS cannot operate correctly if it does not know the date and time. If the UPAS internal battery reaches a very low state of charge (i.e., a state of charge below that at which the UPAS shuts down automatically), the internal clock can lose track of the time. If the internally-saved timestamp is lost, the UPAS will not progress all the way through the power-on sequence (see **Table 5**), and the LED will blink **pink** until the UPAS is able to receive the date and time from a GPS satellite.

To correct this issue, take the UPAS outside to a location where it has a clear view of the sky, and hold it with the front of the housing (the side where the inlet and pushbutton are located) facing up. Wait for the UPAS to receive a GPS signal and progress the rest of the way through the power-on sequence to a solid **pink** LED. It should only take a few minutes for the UPAS to receive a GPS signal. If the LED is still flashing **pink** after 15 minutes, try moving to a better location (for example, further away from tall buildings).

What if the local timestamps in my UPAS log file look wrong?

The UPAS operates and logs data using Coordinated Universal Time (UTC) as the primary timestamp. The UPAS gets the UTC time from GPS satellites, so the UTC timestamps displayed in UPAS log files will always be correct.

Local times are also displayed in UPAS log files for users' convenience. The UPAS assumes that the local time zone is the time zone on the mobile device that was used to program the sample. All local times displayed in the log file represent the primary UTC time converted into the time zone from the mobile device. The offset, in hours, between UTC and the local time zone assumed by the UPAS is written to the Setup Summary section in the log file header and labeled "GPSUTCOffset". If the mobile device is not set to the true local time zone when the sample is programmed, the UPAS will still assume that the local time zone is the time zone on the mobile device. If the UPAS is moved to a different time zone after the sample is programmed, the local time zone assumed by the UPAS will not update; it will remain as the time zone that was on the mobile device used to program the sample.

We recommend working with UTC timestamps during data analysis. If the local timestamps in your UPAS log file are not displayed in your desired time zone, you can use the optional `tz` argument in the `read_ast_log` function in the `astR` R package to convert timestamps to a user-specified local time zone.

8 UPAS Specifications

Operating Conditions	
Temperature	Operating: 0 °C to 60 °C Charging: 0 °C to 45 °C Storage: -20 °C to 50 °C
Relative Humidity	Type tested at 95%, +40 °C (non-condensing)
Altitude	Fully altitude/density-corrected volumetric flow control between 2,500 ft (~760 m) below sea level and 20,000 ft (~6,100 m) above sea level
Flow Performance	
Flow Rate Range	1.0 to 2.0 L min ⁻¹
Flow Rate Accuracy	±4% of set point
Back Pressure	9" H ₂ O at 1 L min ⁻¹
Fault Code Detection	Yes
Flow Performance	Sampling duty cycle range = 13% to 100% active sampling time per 30-second interval
Operational	
Exterior Size	UPAS v2.1: 128 × 70 × 23 mm (5.0 × 2.8 × 0.9 in.). UPAS v2.1 PLUS: 128 × 70 × 36 mm (5.0 in. × 2.8 in. × 1.4 in.).
Weight	UPAS v2.1: 200 g (0.445 lbs.) UPAS v2.1 PLUS: 250 g (0.551 lbs.)
Status Indicator LED	Yes, the LED indicator is also a pushbutton
Body Mounting	Armband, clothing clip, lanyard, safety vest, etc.
Fixed Mounting	Standard ¼"-20 UNC camera-type mount per ISO 1222:2010
Data Logging Frequency	30-second and 1-second log intervals ¹
Noise	< 45 dB
Filter Cartridge	Quick interchangeable design for 37- and 25-mm filters
Electrical	
Internal Battery type	Li-Ion, 24 W-h
Battery Life ²	UPAS v2.1: 20 to 48 h, depending on sample settings ³ UPAS v2.1 PLUS: 15 to 48 h, depending on sample settings ⁴
Battery state of charge (SOC) status indicator	Yes
Battery charge time	5+ h via charging hardware rated for 2 A output
Battery storage	Between 3.6 V to 3.8 V for storage periods > 2 weeks
Battery shipping	Battery Voltage: 3.0 V to 3.3 V UN ID Number: UN3481, Lithium-ion batteries contained in equipment. Hazard Class Label: N/A
Connectivity	Micro-USB, microSD card, and Bluetooth wireless via a free app

Sensors

Sample flow rate	Mass flow sensor; mass flow rates are converted to volumetric air flow rates using on-board measurements of air temperature, pressure, and relative humidity.
Atmospheric	Temperature, pressure, relative humidity
GPS	Does not work inside some buildings. Can be deactivated.
Differential pressure across sample filter	0 to 1500 Pa range
Light	Lux, IR, UV, UV Index
Motion/acceleration	Linear and angular, 6 degrees of freedom (DOF)
Particulate matter	Optical (UPAS v2.1 PLUS only)
CO ₂	Photoacoustic (UPAS v2.1 PLUS only)
VOC/NO _x	Metal oxide; qualitative measurement (UPAS v2.1 PLUS only)

1. The 1-s logging interval is not recommended for normal samples. Review **Section 4** before sampling with a 1-s log interval.
2. Values reported here were determined using a GEN2 PM_{2.5} inlet and a new 37-mm-diameter, 2- μ m pore size PTFE membrane filter from Measurement Technology Laboratories, LLC (PT37P-PF03). Samples were collected indoors, in Fort Collins, Colorado at an elevation of 5,000 ft (1525 m).
3. A battery life of 20 h can be achieved when sampling at 2 L min⁻¹ with a 100% duty cycle, the GPS and LED on, power save mode off, and the logging interval set to 30 s. A battery life of 48 h can be achieved when sampling at 1 L min⁻¹ with a 50% duty cycle, the GPS on, the LED on, power save mode off, and 30-s logging.
4. A battery life of 15 h can be achieved when sampling at 2 L min⁻¹ with a 100% duty cycle, the PM sensor operating continuously, the CO₂ and VOC/NO₂ sensors on, the GPS and LED on, power save mode off, and the logging interval set to 30 s. A battery life of 48 h can be achieved when sampling at 1 L min⁻¹ with a 20% duty cycle; the PM sensor operating continuously; the CO₂ sensor, VOC/NO₂ sensor, and GPS off; the LED on; power save mode on; and 30-s logging.

9 Returns, Warranty, and Repairs

Limited product warranty

Access Sensor Technologies (known hereafter as 'AST') provides a one-year limited warranty on the Ultrasonic Personal Air Sampler (known hereafter as 'this product'). This limited warranty extends only to the original purchaser, for a period of one-year after product is received.

Please note that any warranty services or questions must be accompanied by the order number from the transaction through which the warranted product was purchased. The original transaction will include a list of serial number(s) of the products included in the sale, which are covered by this warranty. The order number serves as your warranty number and must be retained. AST will not offer warranty coverage to products with serial numbers not included in the original sale.

AST warranties this product and its parts against defects in materials, workmanship or function for a period of one year from the original ship date. During this period, AST will repair or replace defective parts with new or reconditioned parts at AST's option, without charge for this repair to you.

Shipping fees incurred from returns for under-warranty service will be split between the customer and AST as follows. The customer will pay all shipping, import and duty fees to ship defective product back to AST, who will then service or replace the products. AST will then pay all shipping, import and duty fees to return the repaired or replaced product to the customer at the original, previously agreed upon customer location.

All original parts (parts installed by AST at the original system build) removed by AST or its authorized service center during the process of any warranty service become the property of AST. Any after-market additions or modifications will not be warranted.

AST makes no other warranty, either express or implied, including but not limited to implied warranties of merchantability, fitness for a particular purpose, or conformity to any representation or description, with respect to this product other than as set forth below. AST makes no warranty or representation, either express or implied, with respect to any other manufacturer's product or documentation, its quality, performance, merchantability, fitness for a particular purpose, or conformity to any representation or description.

Except as provided below, AST is not liable for any loss, cost, expense, inconvenience, or damage that may result from use or inability to use the product. Under no circumstances shall AST be liable for any loss, cost, expense, inconvenience or damage exceeding the purchase price of the product.

The warranty and remedies set forth below are exclusive and in lieu of all others, oral or written, expressed or implied. No reseller, agent or employee is authorized to make any modification, extension or addition to this warranty.

Warranty conditions

The above Limited Warranty is subject to the following conditions:

- This warranty extends only to product distributed and/or sold by AST.
- This warranty covers only normal use of the product. AST shall not be liable under this warranty if any damage or defect results from (i) misuse, abuse, neglect, improper shipping or installation; (ii) disasters such as fire, flood, lightning or improper electric current; or (iii) service or alteration by anyone other than an authorized AST representative; (iv) damages incurred through irresponsible use, including those resulting from non-recommended practices.
- No warranty extension will be granted for any replacement part(s) furnished to the purchaser in fulfillment of this warranty.
- This warranty does not cover any third-party software or virus related problems.
- AST makes no warranty either expressed or implied regarding third-party (non-AST) firmware.

Return of non-defective products

A non-defective product may be returned to AST within thirty (30) days of the invoice date for a refund of the original purchase price with the following amendments/fees:

AST will refund neither the original shipping cost nor the shipping and handling fees incurred from the product's return. No refund will be granted for product that has been opened, used, or tampered with in any way which jeopardizes AST's ability to remarket or resell the product. AST maintains full discretion in decisions regarding a product's fitness for return.

Procedures for obtaining warranty service

To return a defective product, please contact our Customer Service Department for a Return Merchandise Authorization (RMA) number and follow the Return of Products Instructions below.

If the product must be repaired, an RMA number will be issued for shipment to our repair department. Please follow the instructions given by AST technical support staff to ship your product. AST will not accept any shipments without an RMA number.

Pack the product in its original box or a well-protected box, as outlined in the Return Shipping Instructions. AST will not be responsible for shipping damage/loss of any product outside the 1-year AST-paid service period. Ship the product with a copy of your bill of sale or other proof of purchase, your name, address, phone number, description of the problem(s), and the RMA number you have obtained to Access Sensor Technologies.

Upon receiving the product, AST will repair or replace your product (at AST's discretion) and will ship it back to you within two weeks (dependent on parts availability) via common carrier of AST's choice for normal delivery.

AST will pay for shipping back to the customer only within one-year of the original product ship date. The customer assumes full liability for losses or damages resulting from shipping as well as all responsibility to pursue remuneration for such issues with their selected carrier.

After one-year warranty – post warranty repair

Post warranty repair is possible if both customer and AST can agree to terms before initiating such repair. In the case of such agreement, the procedure is the same as outlined above for RMA and shipping. However, the customer is responsible for shipping charges both ways, current labor (at a rate to-be-determined before repair initiation) and the current price of part(s) used in repair.

Warranty exclusions

AST does not offer technical support for any aftermarket firmware/software including installed OS or other programs. AST does not offer service or coverage of any external connective software such as mobile device or personal computer applications, etc. Technical support should be pursued through technical support channels offered by the makers of such software. AST accepts no liability for problems caused by after-market software or hardware modifications or additions. AST is not responsible for giving any technical support concerning the installation or integration of any software or component the customer did not pay AST to install. AST is not responsible for loss of data or time, even with hardware failure. Customers are responsible for backing up any data for their own protection. AST is not responsible for any loss of work (“down time”) caused by a product requiring service. This warranty is null and void if the defect or malfunction was due to damage resulting from operation not within manufacturer specifications including but not limited to accidental dropping, collisions with other objects, water immersion or submersion, overheating (over 130F), application of unapproved solvents/liquids/solids, use of a non-approved battery charger, or any other treatment not associated with typical use. The warranty will be null and void if there are indications of misuse and/or abuse. AST has the option of voiding the warranty if anyone other than an AST technician attempts to open or service the product without AST’s express permission being granted. AST will not warrant any problems arising from an act of God (lighting, flooding, tornado, etc.), electrical spikes or surges, or problems arising out of hardware, software, or additional devices added to complement any system/component bought at AST, including battery chargers, charging and data transfer cords, etc. Under no circumstances will AST be responsible for any refund or remuneration exceeding the original purchase price of the product less any shipping fees. AST will not be held responsible for typographical errors on sales receipts, repair tickets, or on our website. AST makes every effort to make sure all information on our website and in literature pertaining to the product is correct.



**ACCESS SENSOR
TECHNOLOGIES**

Sampling made simple.®

Revision 1.8
August 2025

<https://www.accsensors.com>